

Dynamics of Bacterial Community Structure and Properties of Electricity Generation in Microbial Fuel Cells



Shizuoka University



Faculty of Engineering

M2 Shuji Yamamoto

Shizuoka University

Situated in Shizuoka prefecture in Japan

Our university has 2 campuses, 6 faculties

Total over 10,000 students



Hamamatsu-campus



Shizuoka-campus

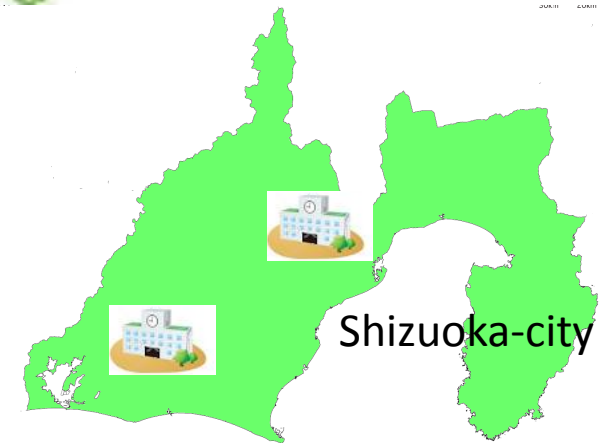

Hamamatsu-city

Shizuoka-city

We belong to Faculty of Engineering and
Department of Material and Chemical Engineering

Our Laboratory

Lab. theme

~Bacterial community structure~

2 doctor, 4 Master and 5 Bachelor students

4 main projects

Nitrogen cycle
In the Lake

Microbial Fuel Cell

Interaction of
microbes

Dechlorination



Lab. members

What's Microbial Fuel Cell?

A **m**icrobial **f**uel **c**ell (**MFC**) is a device that converts chemical energy to the electrical energy by the catalytic reactions of microorganisms.

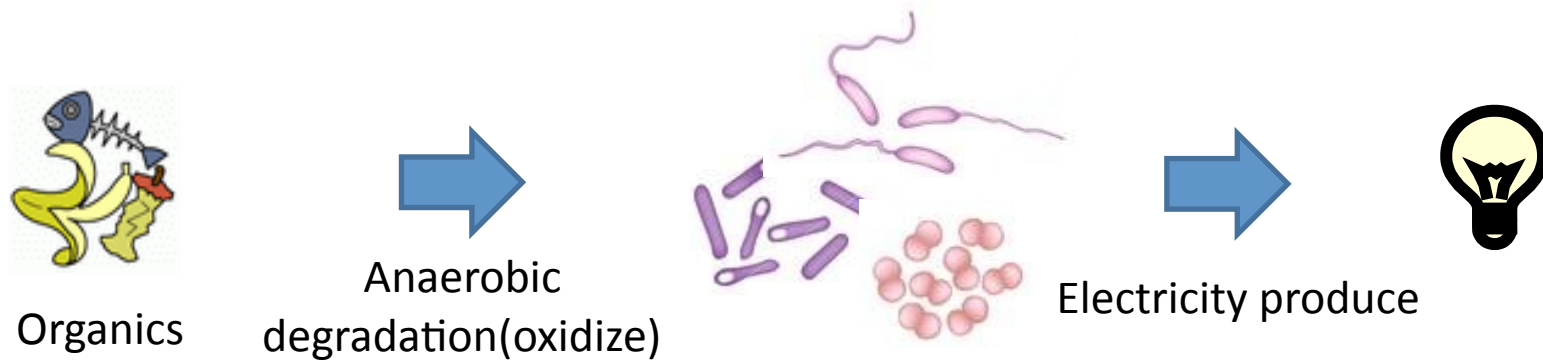

Features

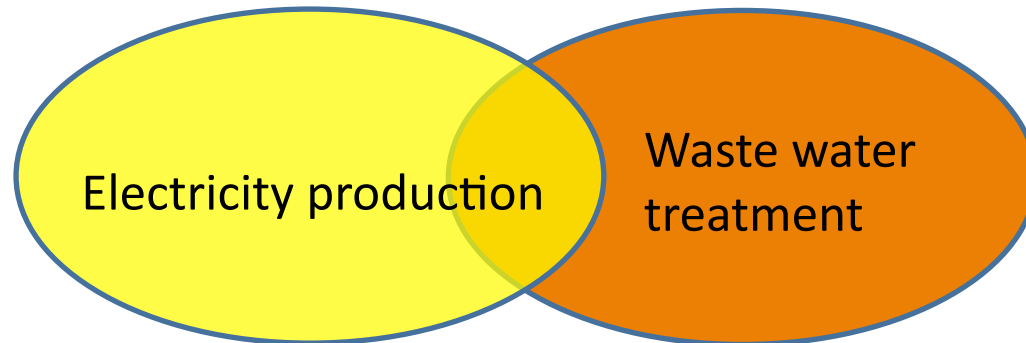

MFC can perform simultaneously waste water treatment and electricity production.

Principle of MFC

Power generating microorganisms (Exoelectrogens)

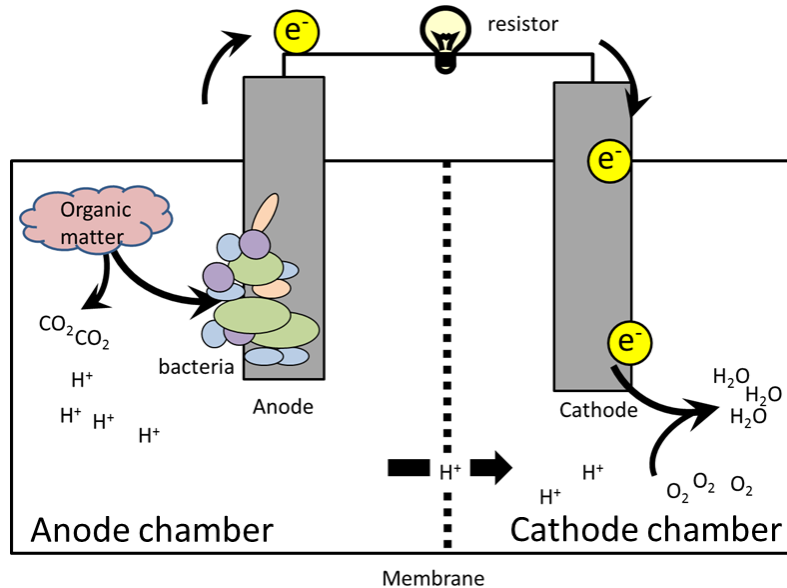

Shewanella
Geobacter
Clostridium
Pseudomonas
...

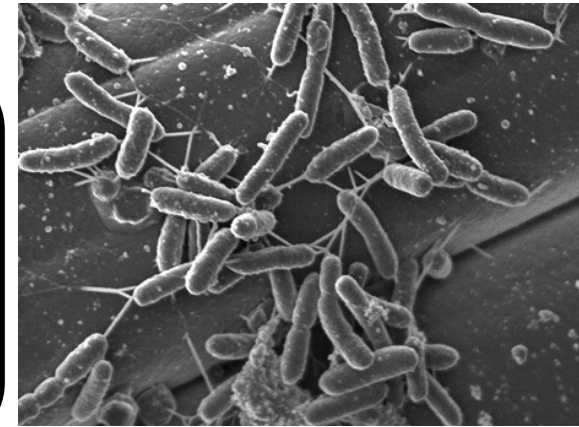

Shewanella oneidans MR-1

The anode and cathode chambers are separated by a proton exchange membrane, and two electrodes are connected with wire and an external resistor.

The bacteria grows on the anode, oxidizing organic matter and releasing **electrons** to the anode as electron acceptor and **protons** to the solution.

The cathode is aerated to provide dissolved oxygen for the reactions of **electrons, protons** and **oxygen**

By these reactions, current is produced.

History of MFC

1911 Discover principle of MFC (potter, M.C)

1999 Mediator-less MFC (Kim, B.H et al)

Directly electricity transfer (Kim, B.H et al)

2002 read the genome of *Shewanella oneidensis* MR-1 (Heidelberg, J.F et al)

2003 "" *Geobacter sulfurreducens* PCA (Methe, B.A et al)

2004 Air-cathode MFC (Liu, H. et al)

2005 nanowire produce (Gorby, Y.A et al)

For this 10 years,
MFC power increased 1,000,000 times.

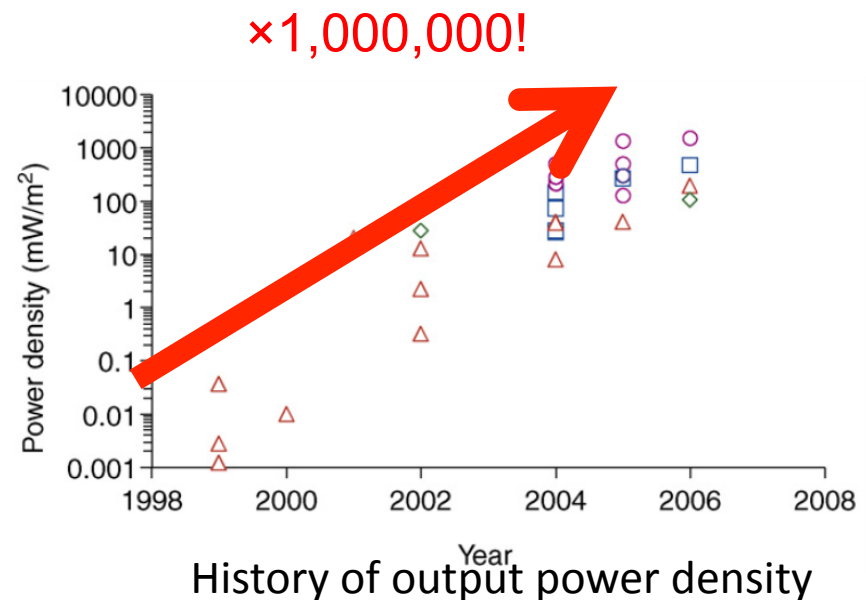

Several types of MFCs



Air-cathode MFC



Paddy field MFC

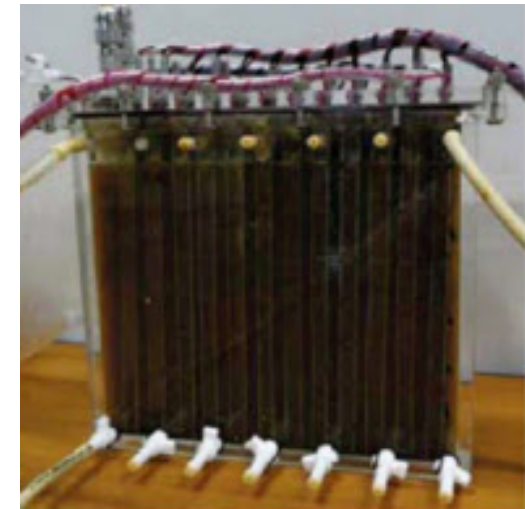

Stack MFC

Air-cathode MFC

Single-chamber MFC was first reported in the year 2002.

There is no necessity for Cathode chamber and aeration, and it can be low-cost.

Paddy field MFC

This MFC uses sediment as anode chamber and water as cathode chamber.

if there is a paddy field and simple equipment,
supply of clean energy can be expected all over the world.

Stack MFC

This MFC aims for high power generation by combining a few MFCs.

Problems

MFC is a very excellent system for energy supply.

However, In order to put it in practical use, there are many problems which should be solved.

At present, the energy and treatment amount obtained by MFCs is **too small** as compared to **anaerobic treatment processes**, such as methane fermentation.

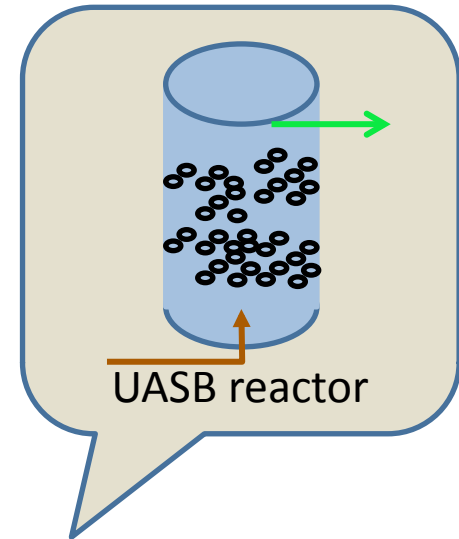

	present	target
output	0.1~1,000 W m ⁻³	Stable 1,000 W m⁻³
Treatment amount	0.1~10 kg-CODm ⁻³ d ⁻¹	10~20 kg-CODm ⁻³ d ⁻¹
cost	\$5,300 per kW	\$1,000 per kW

In our laboratory,

We have three MFC projects.

any area of research is studied from a viewpoint of microbial community structure.

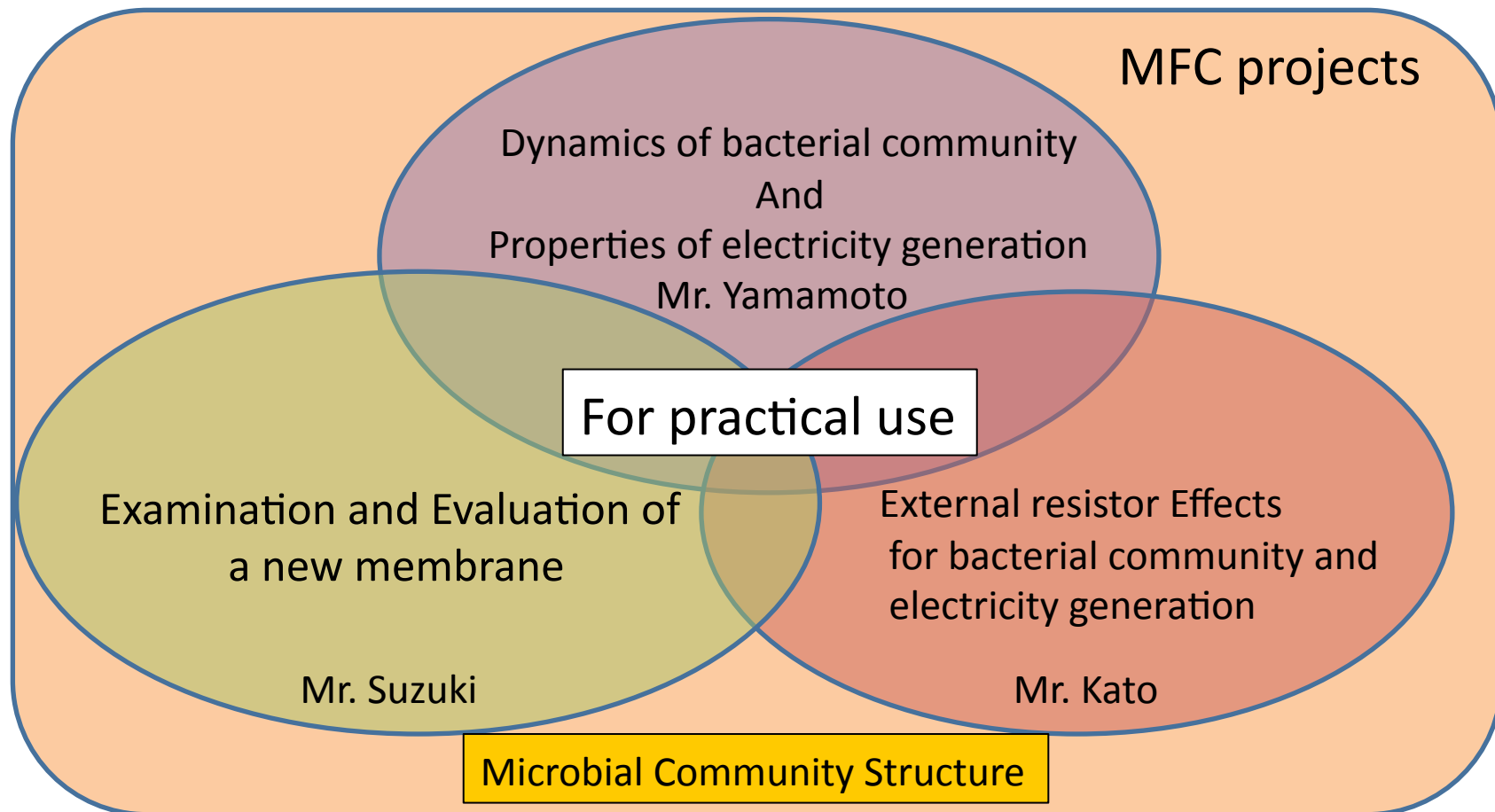

Dynamics of bacterial community
And
Properties of electricity generation

Background

For waste water treatment, complex microbes and organic matter are present in waste water.

under the these unstable conditions
How is the property of electricity generation?
&
How do bacterial community adapt to MFC?



Using domestic garbage as electron donor (organics),
We analyzed the relationship between
bacterial community and **properties of electricity generation**.

Material and Method

We constructed continuous MFC system using domestic garbage.

- Garbage is obtained from the canteen.
- Garbage is degraded in Energy bottle and transferred to MFC.

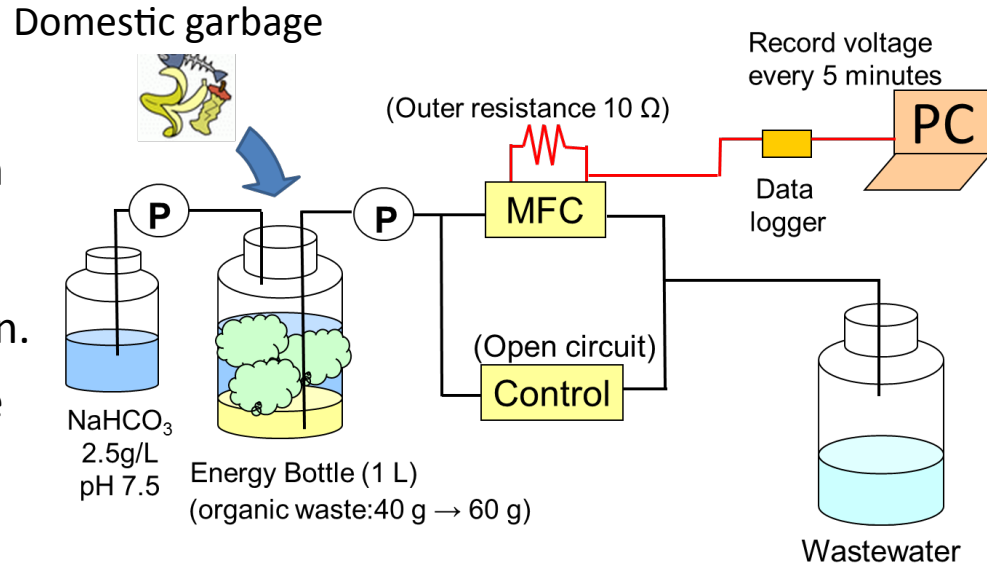

Continuous MFC system

- Anode Chamber : 36 mL
- Inoculum source : Rice paddy soil (0.4 g)
- Anode : 5 x 5 x 5 mm carbon graphite (130 pieces)
- External residence : 10 Ω
- Solution of degraded organic waste was continuously fed (0.25 d⁻¹ to 1.0 d⁻¹)
- Cathode surface Area : 16 cm² (4 x 4 cm)

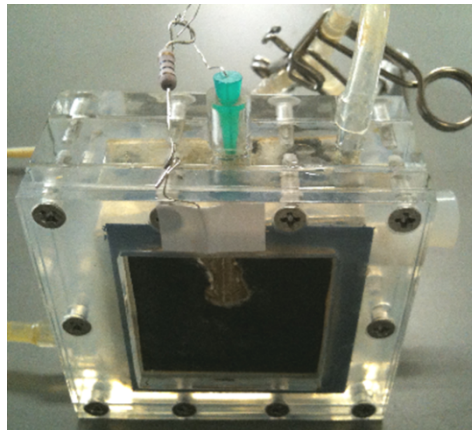

MFC constitution

MFC image

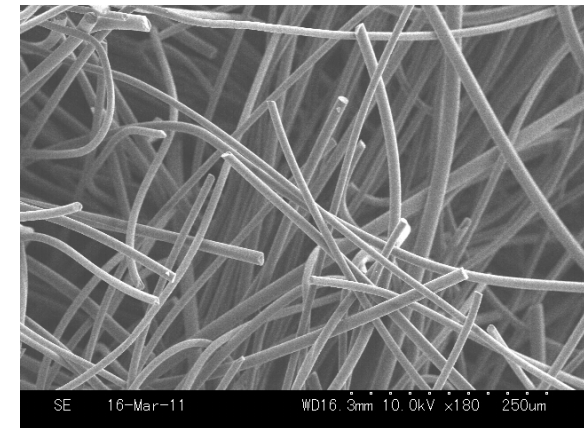

Anode Image

Electrochemical Analysis : Voltage measurement

Biological Analyses : Clone library Analysis , PCR-DGGE Analysis

Electrochemical Analysis

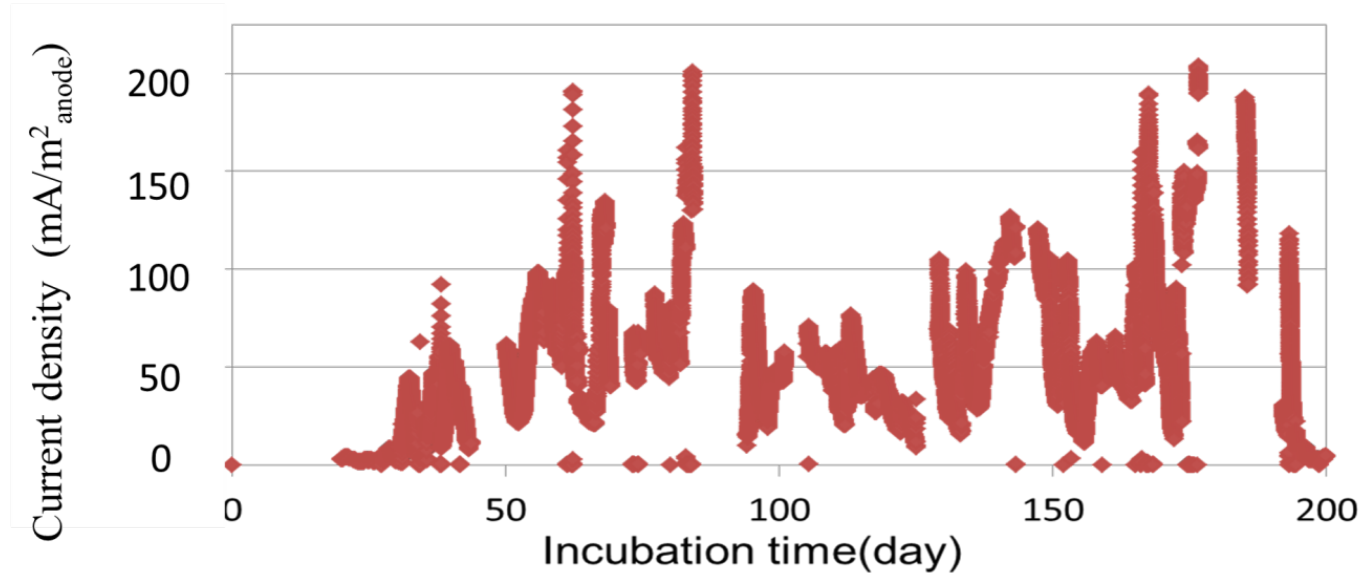

- Internal resistance decreased by microbe accumulation.
- Furthermore, open circuit voltage and maximum power density increased.

Incubation time (day)	Open circuit voltage (mV)	Current density (mA m ⁻² anode)	Maximum power density (mW m ⁻³)	Internal resistance (Ω)
27	160	4	120	2274
34	500	44	4920	370
69	300	138	5320	163
105	475	63	6690	200
167	466	198	6880	140
182	504	218	7440	112



The MFC performance developed during experiment.

Clone Library Analysis

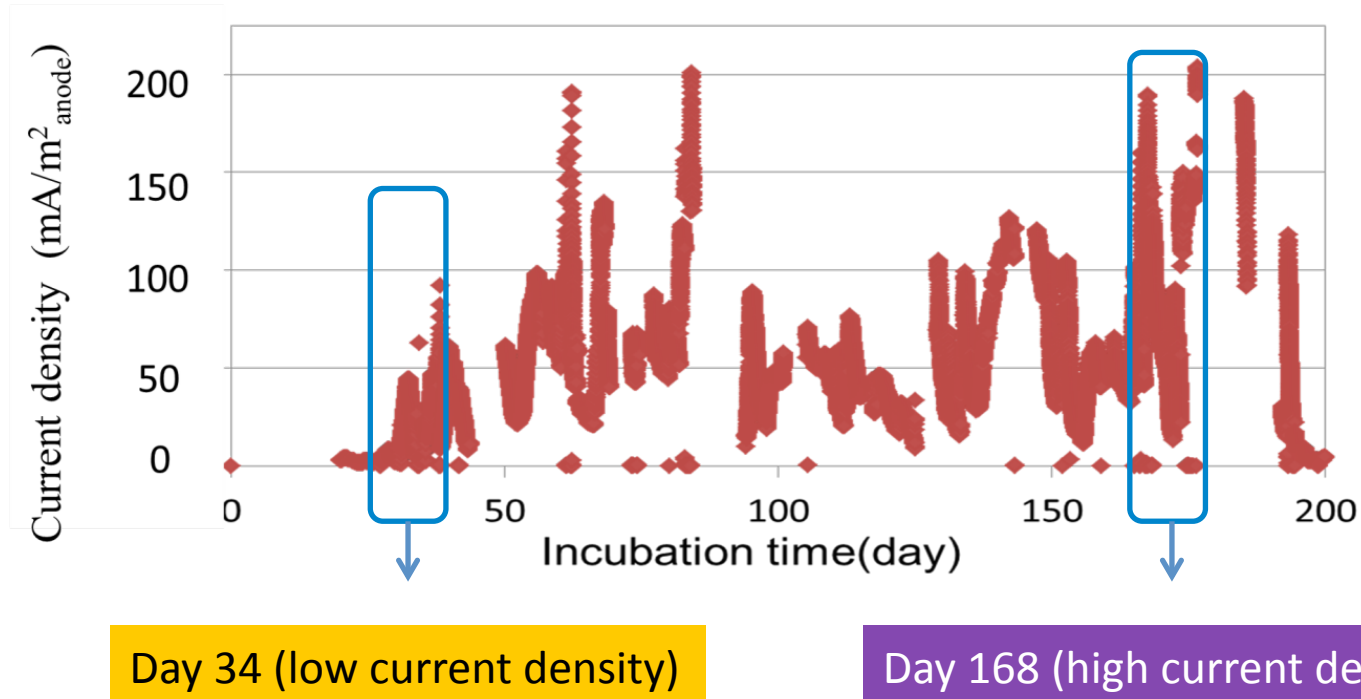

- In order to understand differences of microbial ecology due to property of electricity generation, clone library analysis was conducted at day 34 and 168.

Clone Library Analysis

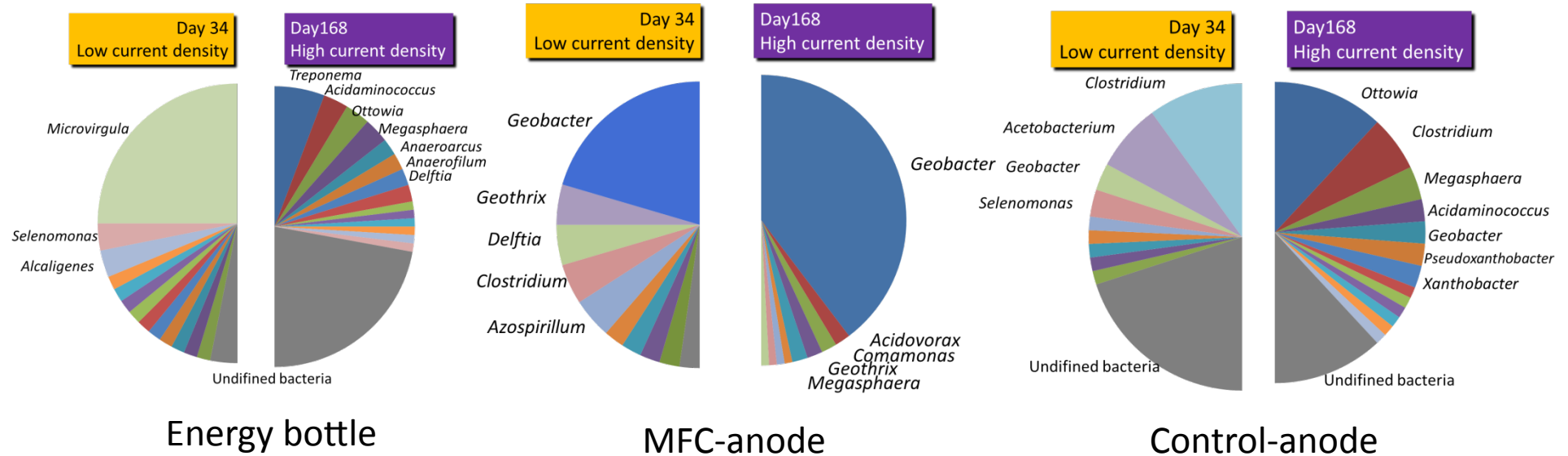

- In Energy bottle, microbial ecology was complex.
- On the MFC anode, *Geobacter sp.* a known exoelectrogen was detected at day 34.
- In addition, Although Energy bottle solution was transferred to the MFC, *Geobacter sp.* became more dominant species at day 168.
- On the other hand, exoelectrogen did not become dominant on the Control anode.

Our MFC was able to construct the microbial ecology for effective electricity production.

Conclusion

- MFC performances developed during this experiment.
- Despite the supplyment of complex microbes, exoelectrogens (*Geobacter sp.*) were selectively accumulated and dominated on the MFC anode.

We have succeeded in building an efficient MFC under unstable condition using domestic garbage.

However...

- It took long time (20 days) for producing electricity.
- Maximum power density was low (7.4 W m^{-3}) compare to practical use ($1,000 \text{ W m}^{-3}$).



Must study more about microbial community structure for effective electricity generation.

Thank you for your attention

Effect of proton exchange membrane and inoculum on the power generation and bacterial community in MFC



Shizuoka Univ. KEI Suzuki

MFC : Microbial Fuel Cell

Next-generation system of electricity production that can produce electricity directly from biomass energy

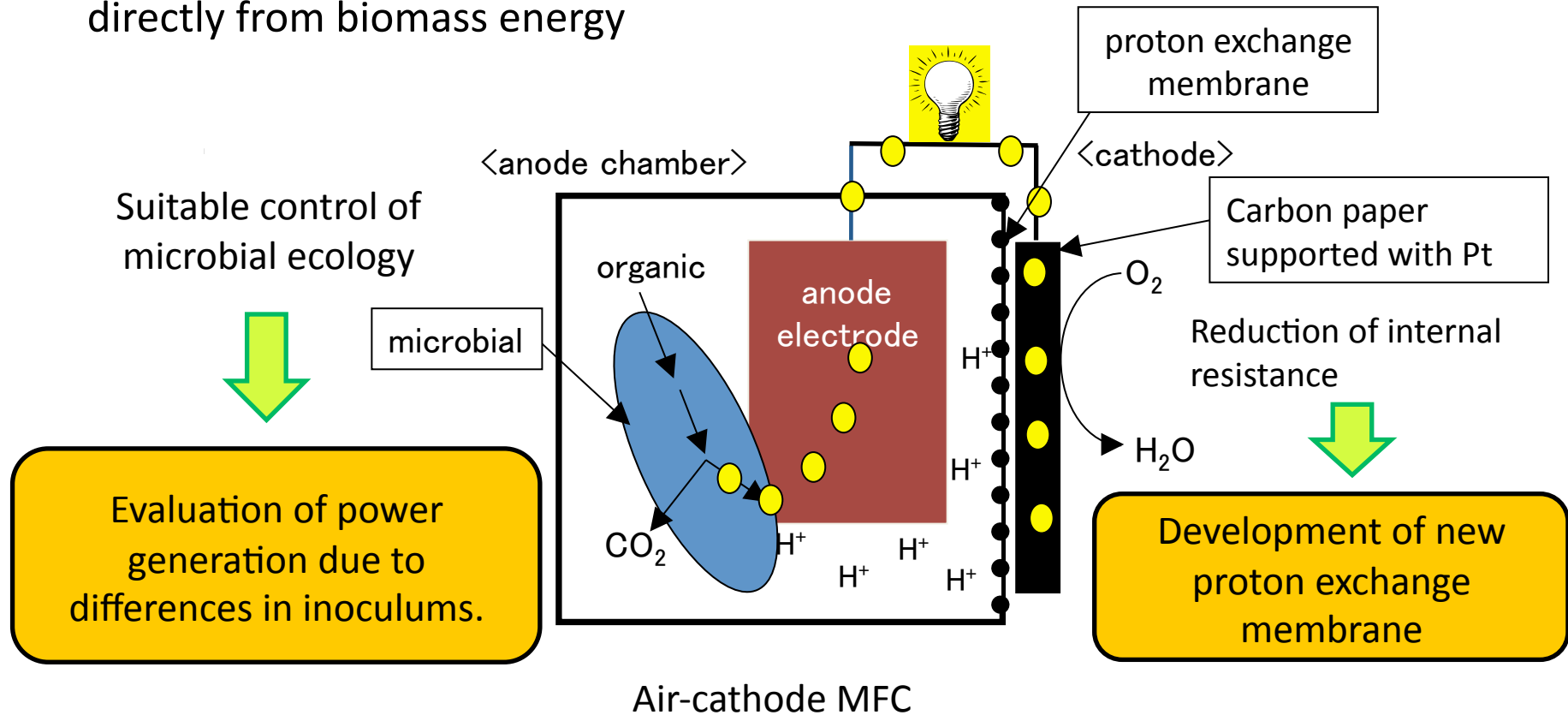

We investigate that power generation of MFC have to do with the difference proton exchange membrane and the inoculums.

Design of MFC

MFC No.	inoculum		membrane
MFC1	Sediment of lake (0.4 g)	organic acid	SMEA
MFC2	Sediment of lake (0.4 g)	organic acid	Nafion 117
MFC3	–	organic acid	Nafion 117
Control	Sediment of lake (0.4 g)	organic acid	Nafion 117

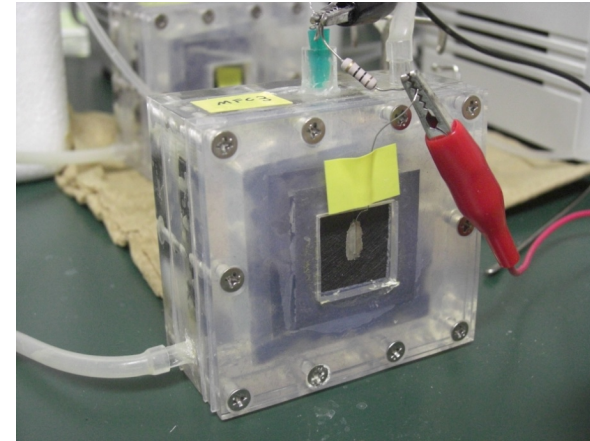

SMEA

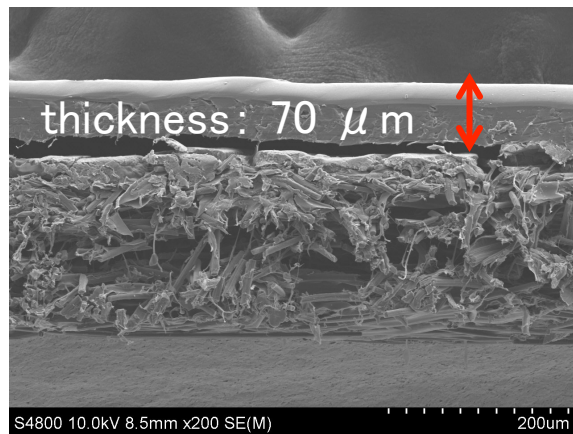

Nafion 117

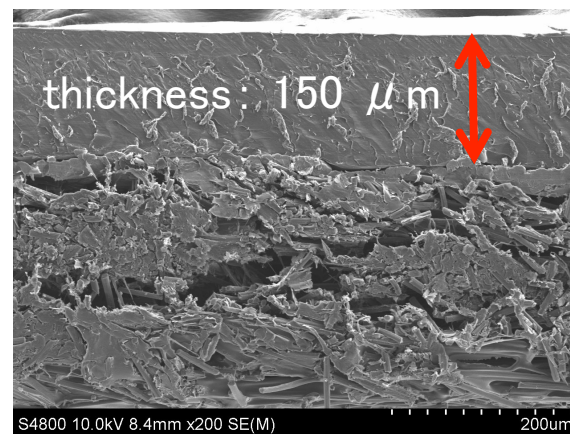

- As control condition an open-circuit control was also set up.
- Anode chamber : 36 mL
- 130 pieces of the 125 mm³ anode electrodes were included.
- External resistance : 10 Ω
- Cathode : 4.0 cm² carbon paper supported with Pt (0.5 mg cm⁻²).

Design of MFC

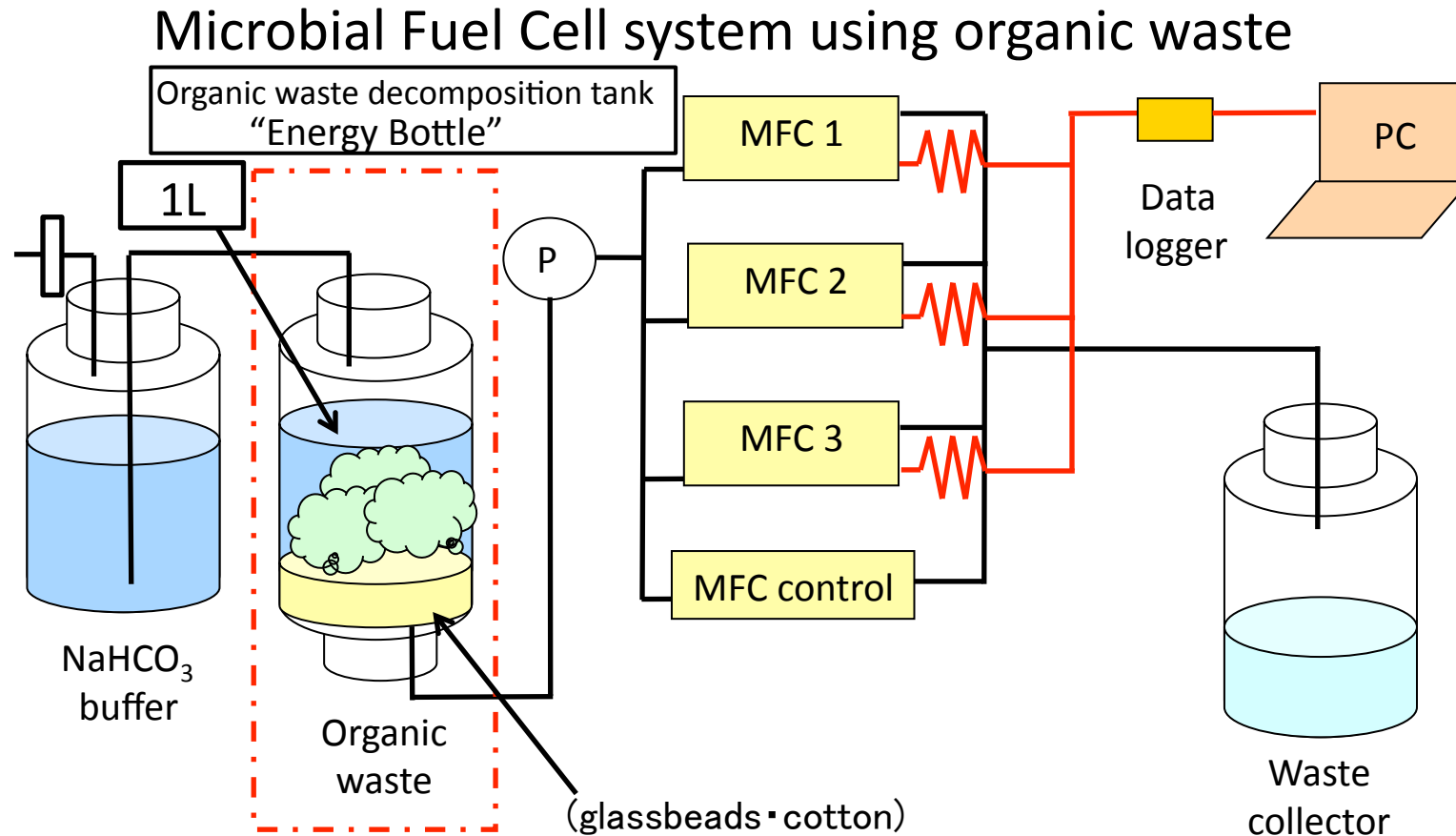

- Hydraulic retention time : 24 h
- Voltage was measured every 5 minutes
- When voltage is low, we filled with 20 g of raw garbage in the Energy Bottle.

Result I : Monitoring of current density

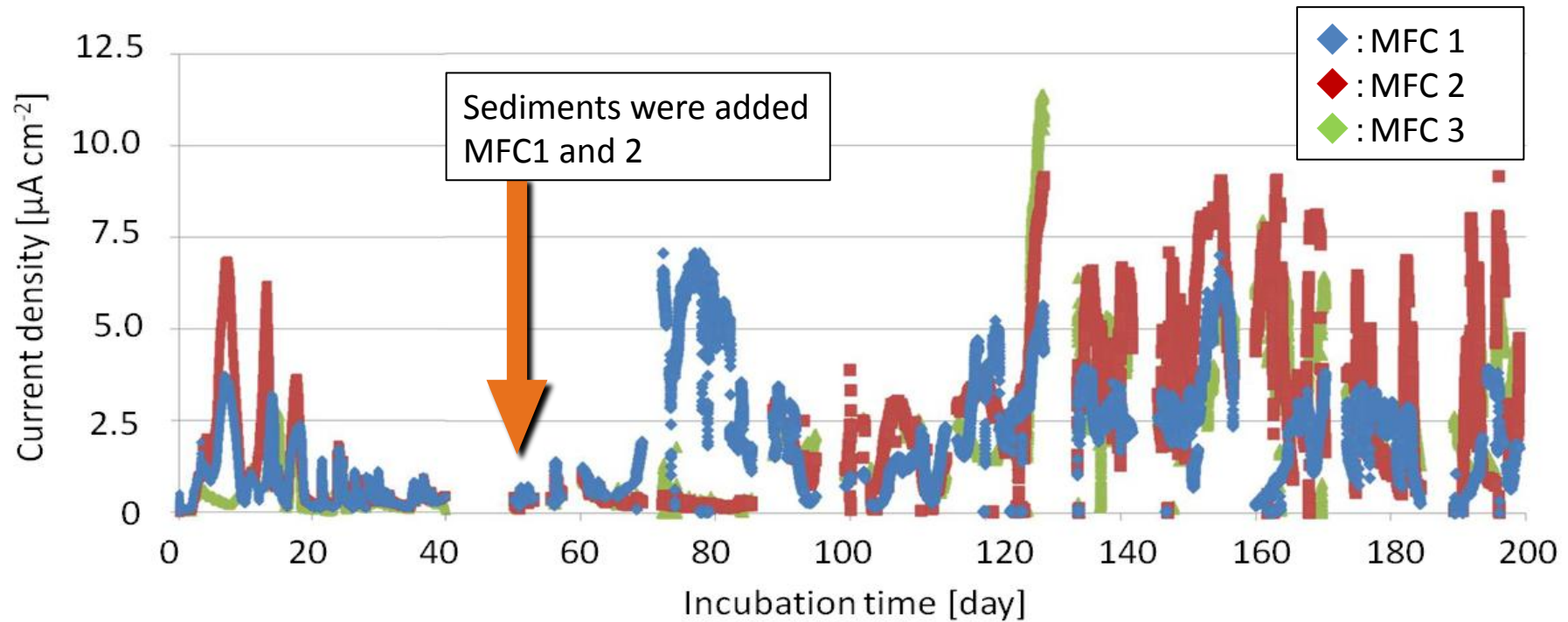

Incubation day	MFC1				MFC2				MFC3			
	V_{OC} [V]	I_{MAX} [A]	P_{MAX} [Wm^{-3}]	R_{int} [Ω]	V_{OC} [V]	I_{MAX} [A]	P_{MAX} [Wm^{-3}]	R_{int} [Ω]	V_{OC} [V]	I_{MAX} [A]	P_{MAX} [Wm^{-3}]	R_{int} [Ω]
day3	0.59	0.0002	0.73	<u>2900</u>	0.57	0.0003	0.81	<u>3600</u>	ND	ND	ND	ND
day79	0.51	0.0013	2.83	<u>560</u>	ND	ND	ND	ND	ND	ND	ND	ND
day127	0.58	0.0005	1.50	950	0.50	0.0007	2.53	<u>300</u>	0.48	0.0006	2.41	300
day163	ND	ND	ND	ND	0.42	0.0006	1.86	630	0.44	0.0003	0.97	930

Confirmed the reduction of internal resistance



The result suggested that exoelectrogens were enriched on the anode.

Result II : 16S rRNA gene clone library analysis (day168)

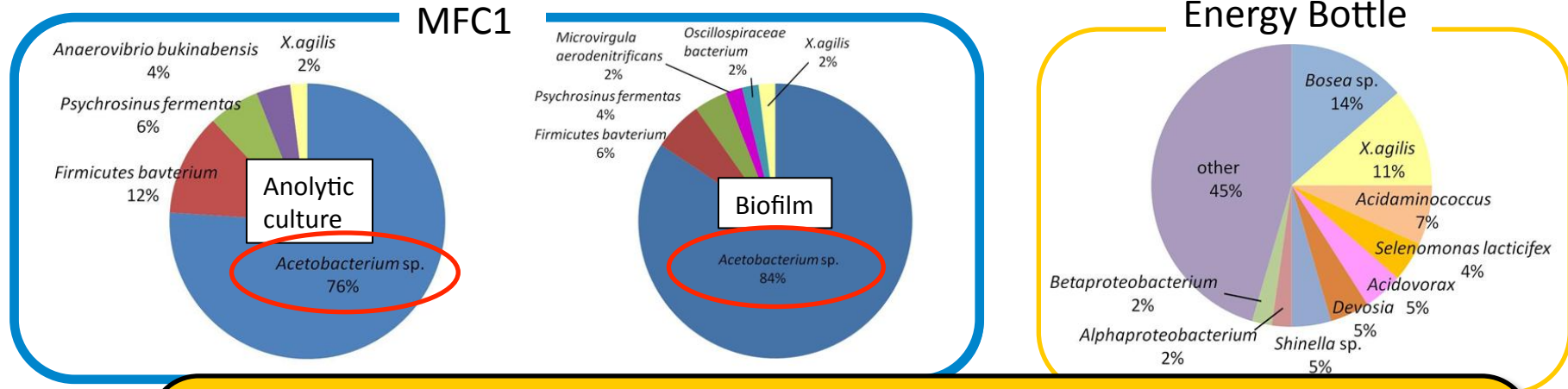

These results were suggested that

- 1) MFC has a strong bias for microbial communities, and
- 2) there is a interactive relationship between bacterial communities of analytic culture and biofilm.

- In
- Altho circuit,

was different from the anode electrode biofilm.

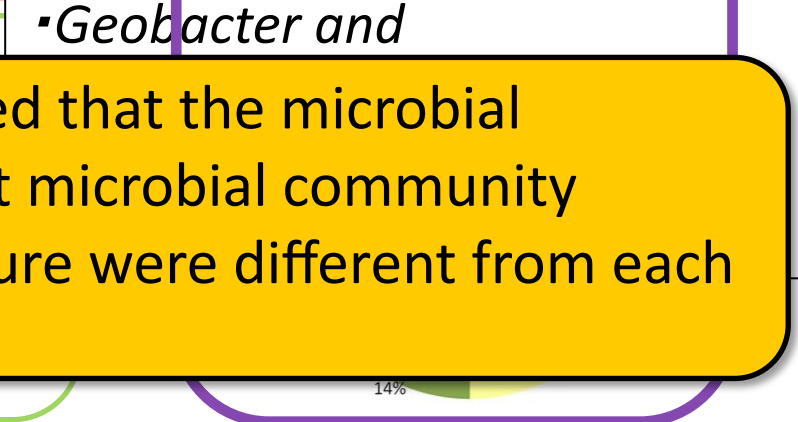
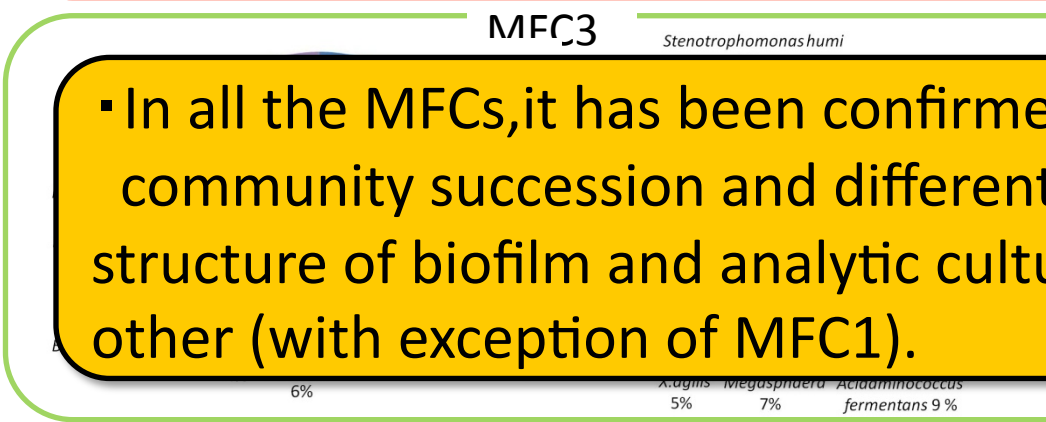

▪ In all the MFCs, it has been confirmed that the microbial community succession and different microbial community structure of biofilm and analytic culture were different from each other (with exception of MFC1).

Result IV : MDS analysis based on DGGE analysis

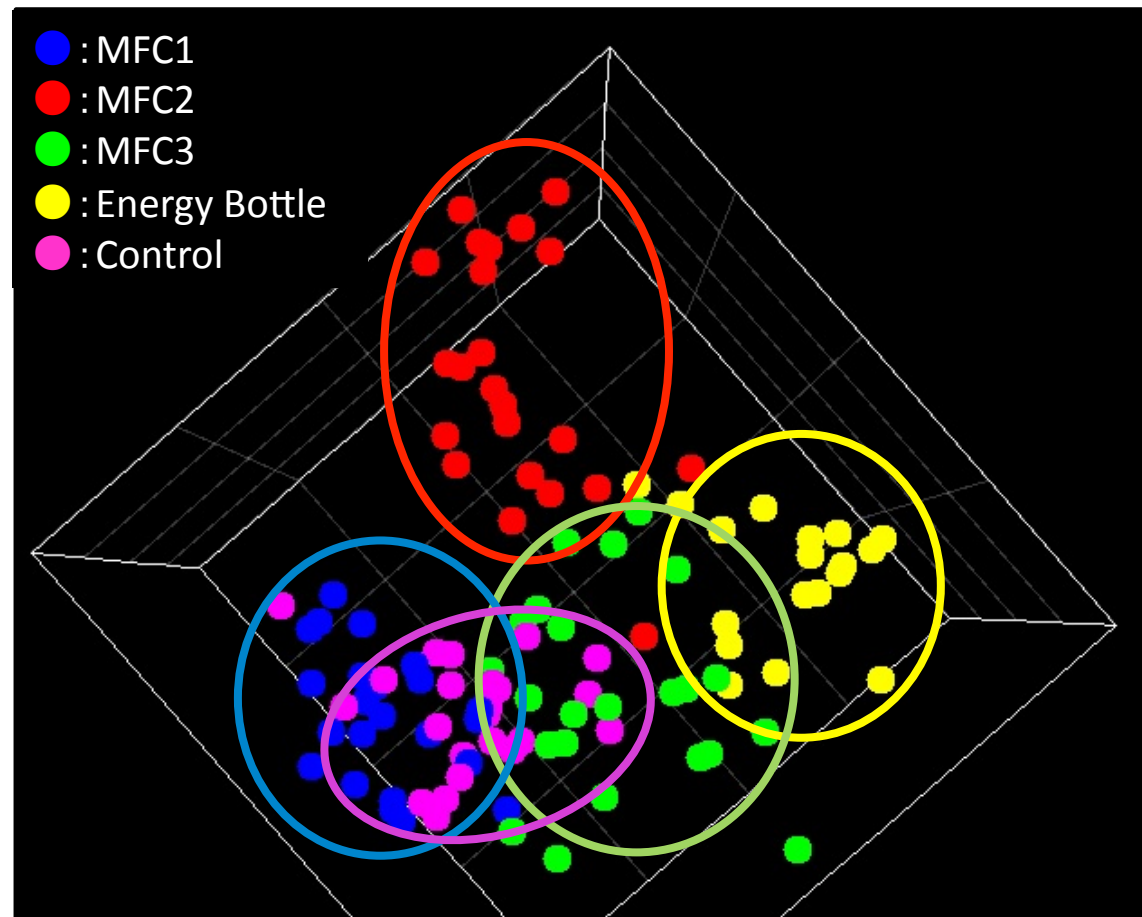

It was confirmed that the unique microbial community structures had developed corresponding to the membrane properties.

Conclusion

- The properties of electricity generation were almost similar in all MFCs, suggested that SMEA is as equal as Nafion117.
- However, bacterial communities structures were different from each other.
- The flexibility of bacterial communities was important for generating electricity from MFC.

Thank you for your attention

Effect of external resistance on total properties of MFC



Shizuoka University

Yutaka Kato

Why external resistance important?

- It has been reported that external resistance affects the electron transfer mechanism from microbes to anode.

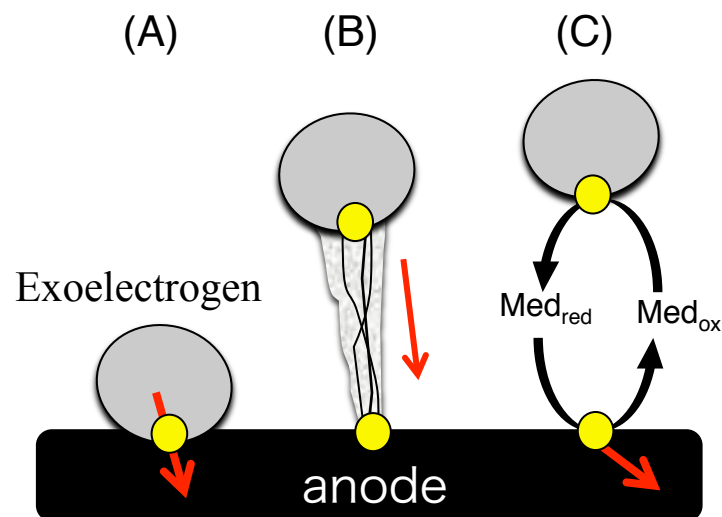
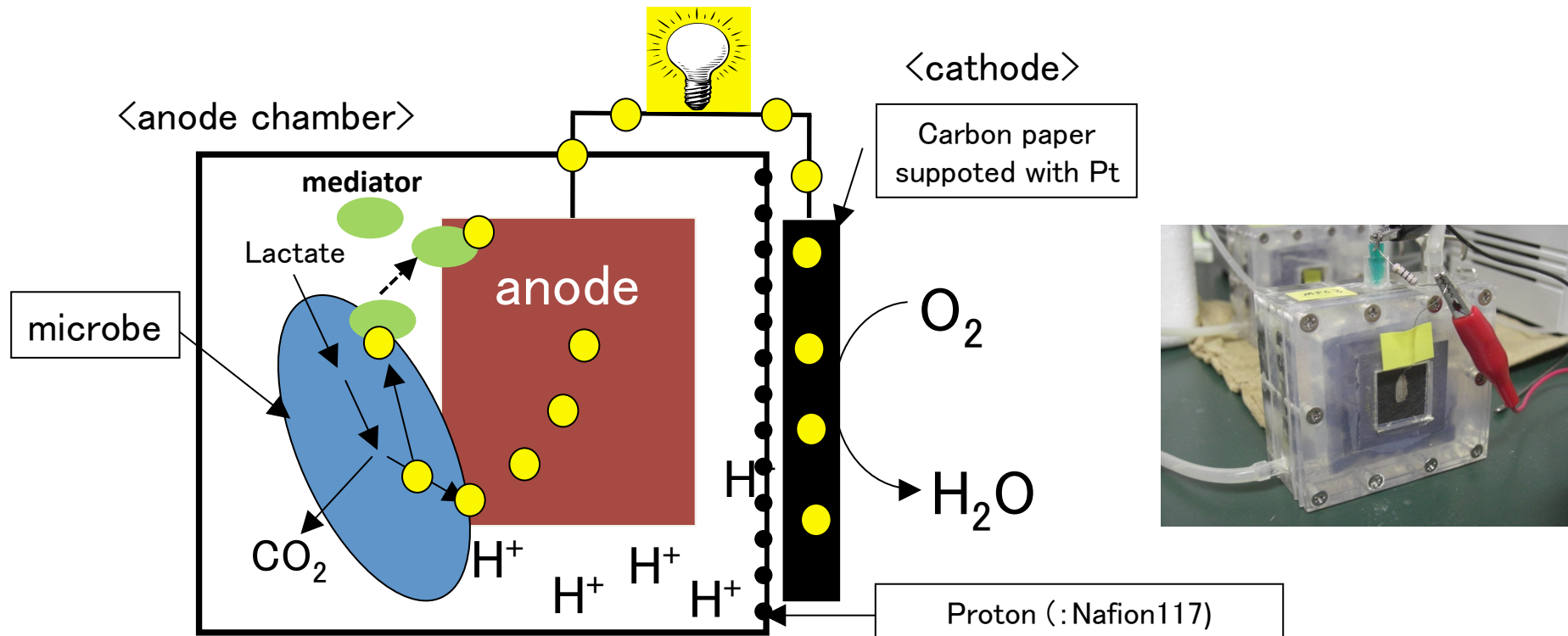

Fig. Schematic representation of electron transfer by exoelectrogen from cells to anode

- (A) Direct electron transfer
- (B) Electronically conducting nanowires
- (C) Mediated electron transfer

◆ Using two different external resistances (**10Ω: LR**, **1kΩ: HR**), how affect electron transfer mechanism of the exoelectrogen and what makes a difference in the power generation properties.

Material and Method



Experimental conditions

- Anode : carbon graphite (area:40 cm²)
 - Cathode : Carbon paper supported with Pt (0.5 mg Pt cm⁻²)
 - Inocuration : sediment from Sanaru Lake (0.4g)
 - Supplemented with 20 mM lactate
 - External resistor : 10 Ω (LR) and 1k Ω (HR) each MFCs
- There were anaerobic in anode chamber.

Result - Current density -

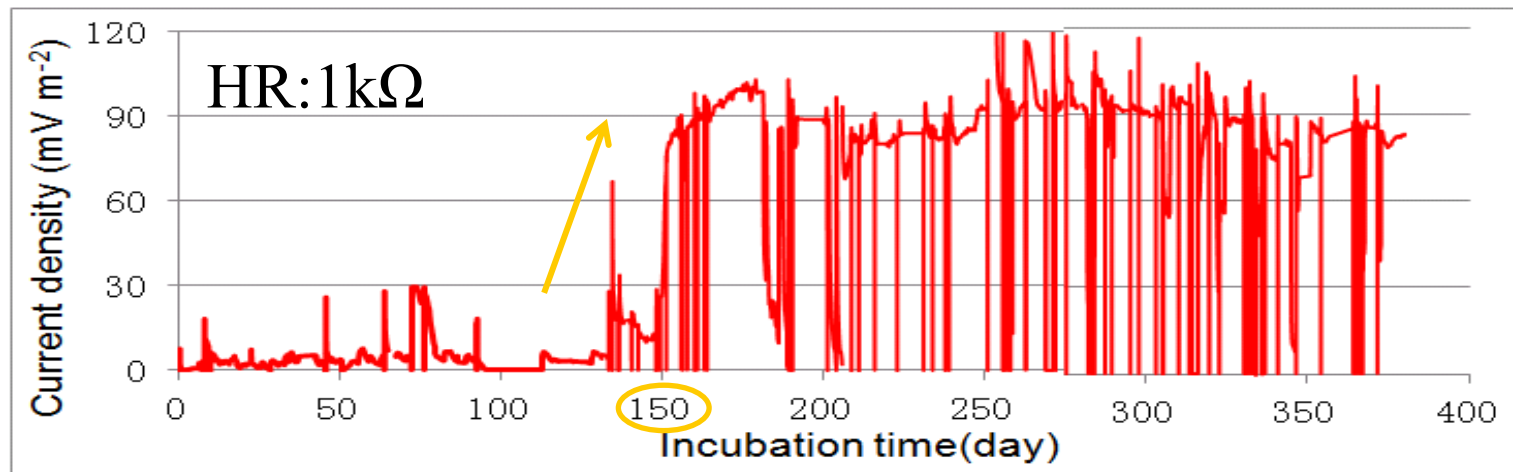
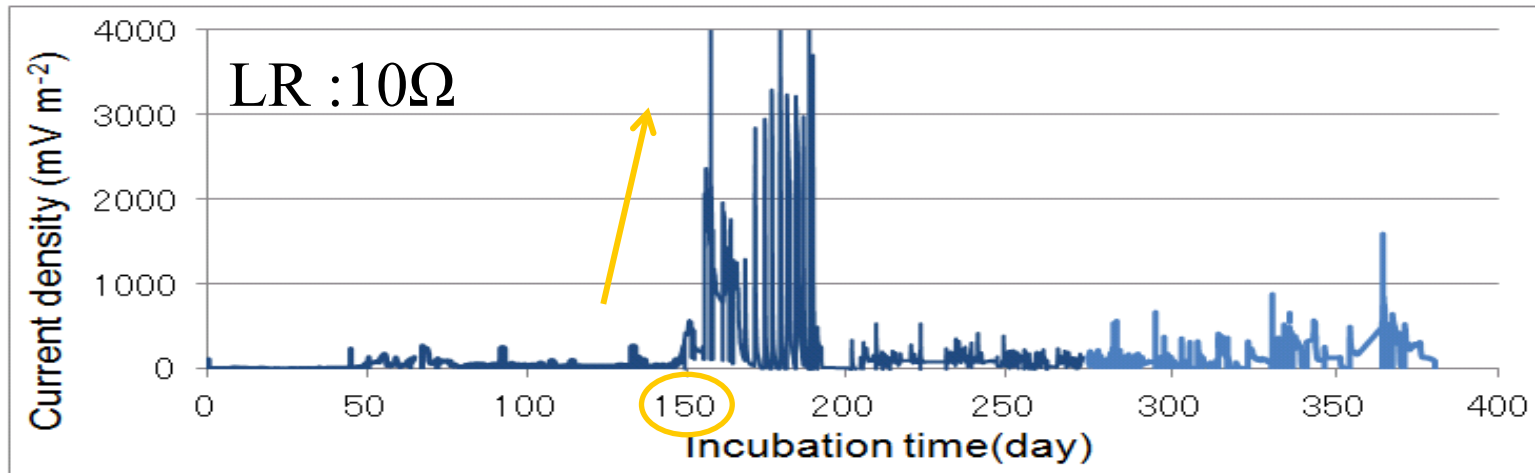

- The increase of current density observed at around 150 days at 2200 mA m⁻² and 85 mA m⁻² in LR-MFC and HR-MFCs, respectively.

◆ To investigate their properties of both MFCs, (1) Electrochemical and (2) Microbial community structure analyses were conducted.

(1) Electrochemistry analysis(i) - Chrono Potentiometry -

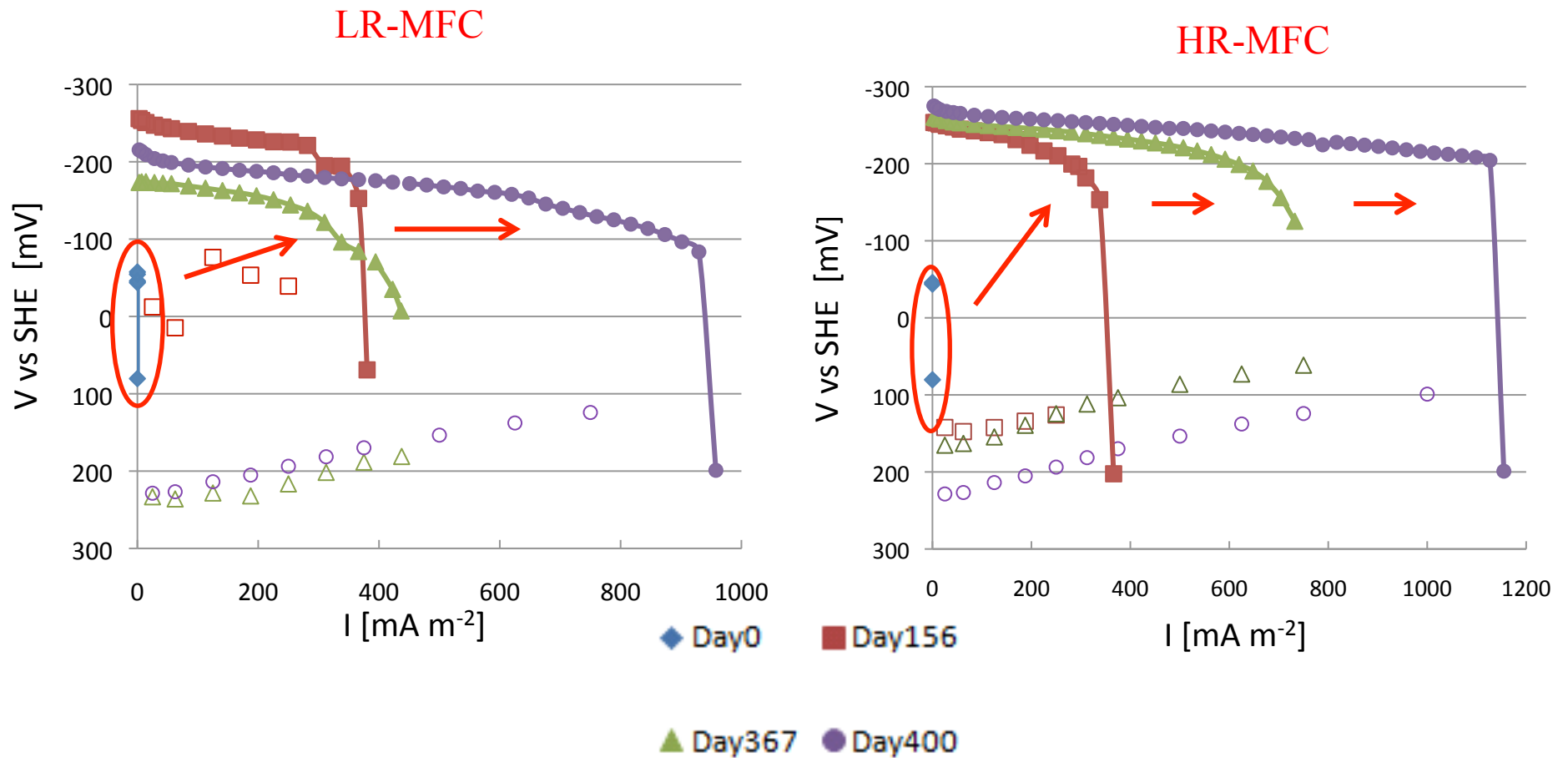

Both MFCs improved better power generation capacity than initial condition.

Performance of HR-MFC was better than that of LR-MFC.

Conclusion

- During the high current density in LR-MFC, direct and mediated electron transfer mechanisms occurred.
- After the current density decreased, electron transfer mechanism was only the direct electron transfer.
- Electron transfer in HR-MFC was only direct electron transfer at initial culture.
Recently, HR-MFC use nanowires mechanisms, too.
- HR-MFC had direct and nanowires electron transfer mechanism was better performance than LR-MFC.

Thank you for your attention!



Functional Analyses and Population Dynamics of Denitrifying Bacteria in Sediment of Eutrophicated Brackish Lake

Shizuoka Univ.

○ Masanori KURAHASHI,
Yuto KUDO, and Hiroyuki FUTAMATA

Background & Objective

Lake Sanaru is a brackish lake and also a representative eutrophicated lake in Japan.

Shin River

Upper site

Danzu River

Nitrate (NO_3^-), nitrite (NO_2^-) and ammonium (NH_4^+) cause eutrophic environments.



Shin River

Down site

Kyu-Shin River

We have been studying about nitrogen cycle of microorganisms for clean up the water environment.

Nitrogen cycle

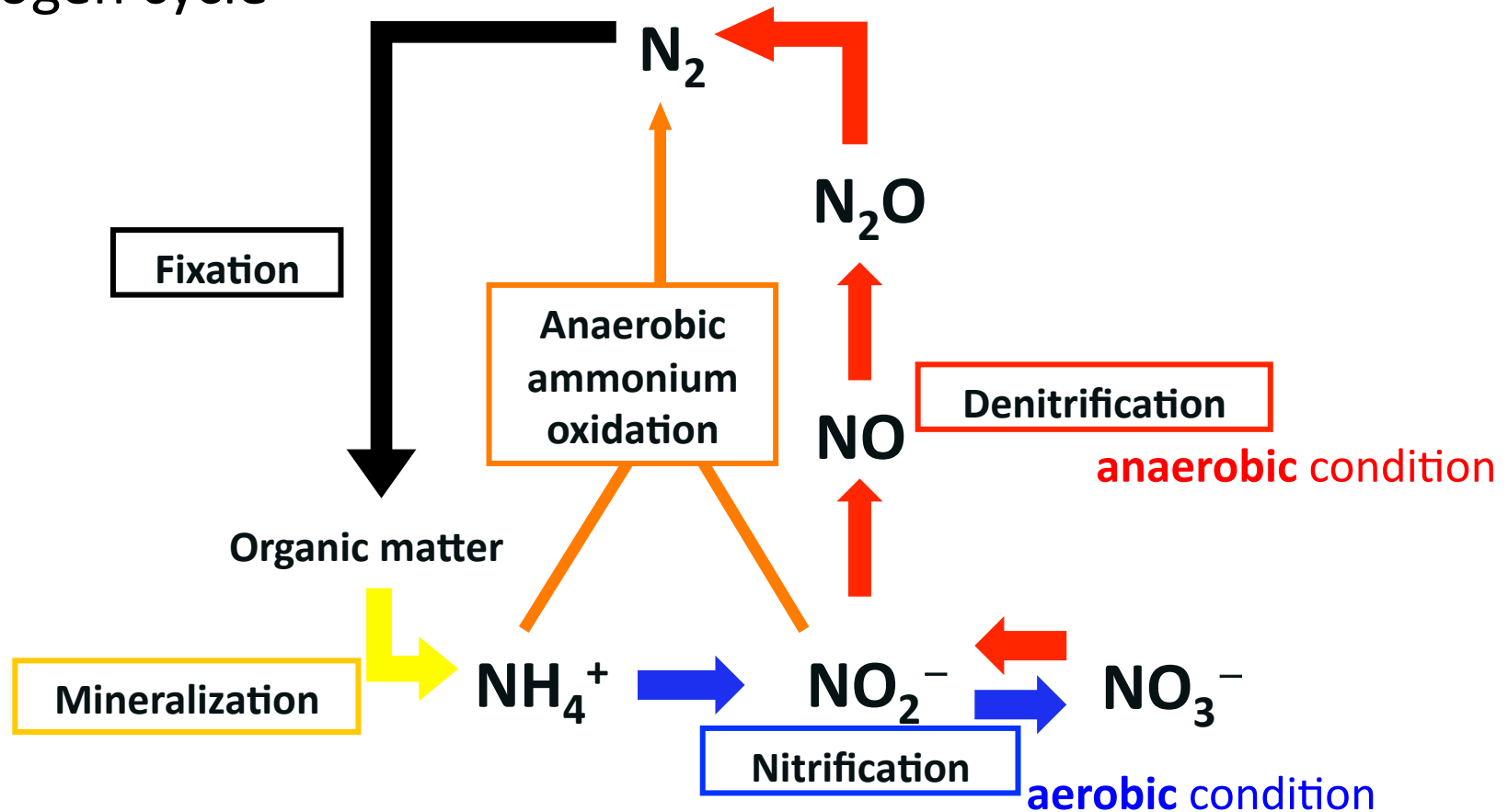

The nitrogen cycle is the process by which nitrogen is converted to its various chemical forms.

Nitrification and denitrification are important processes in the nitrogen cycle.

These processes are carried out by microbes.

Denitrification process

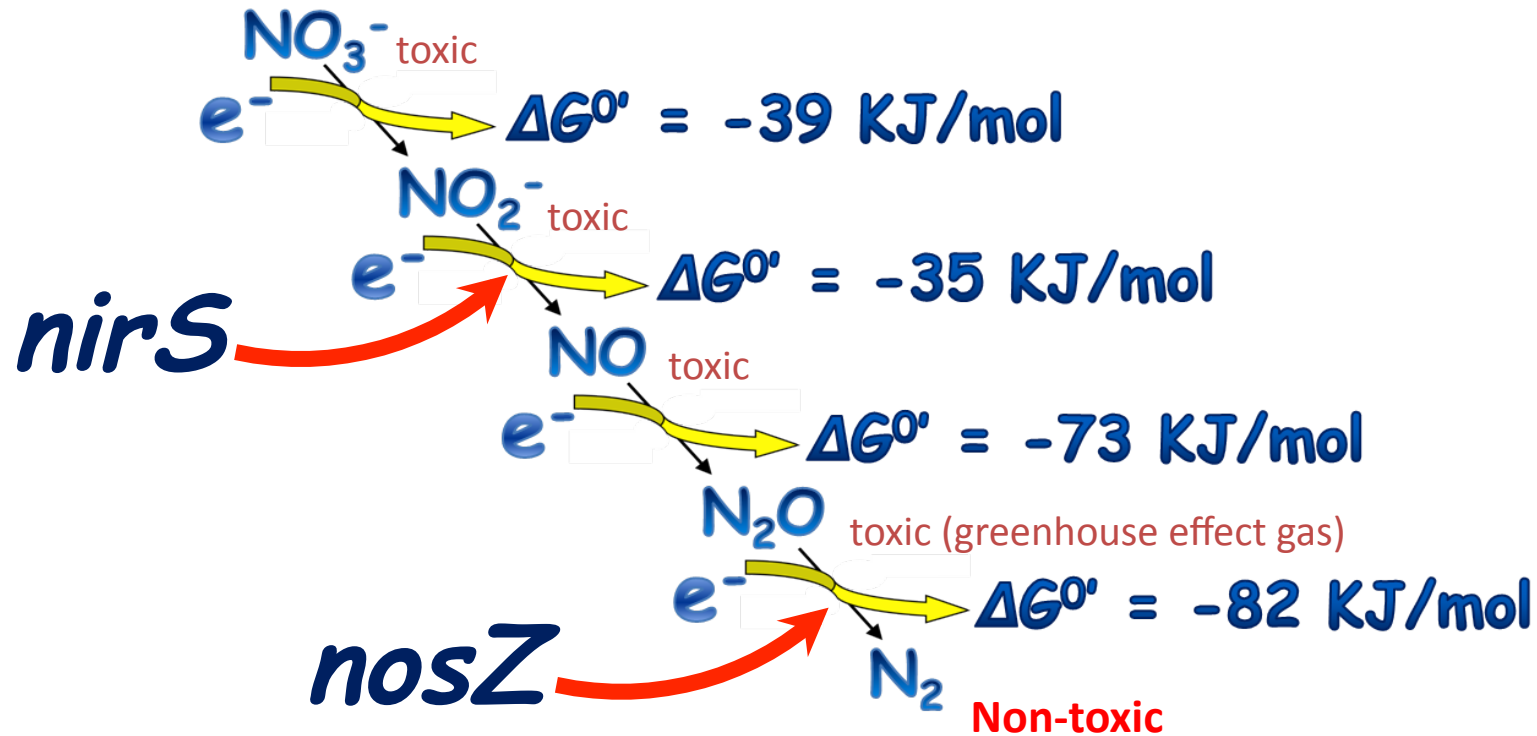

Denitrification is an alternative respiratory process in which nitrogen oxides such as NO_3^- and NO_2^- are used as electron acceptors and reduced to N_2O and N_2 gases under oxygen-limiting conditions.

we analyzed the nitrite reductase gene (*nirS*) and nitrous oxide reductase gene (*nosZ*).

This time, I give a presentation on *nosZ* which performs the last step (detoxification) of denitrification.

Result & Discussion

Measurement of bacterial population

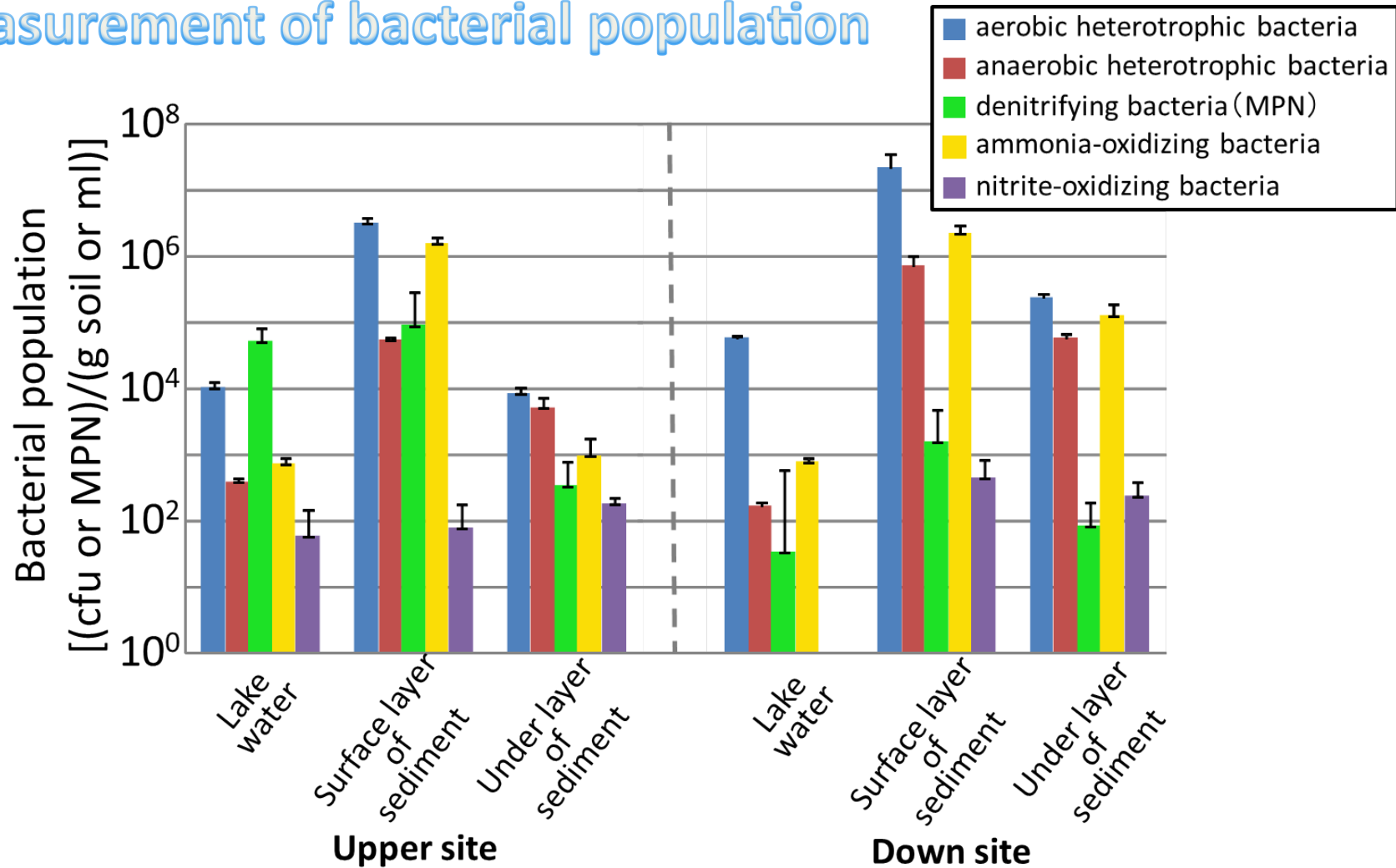

The population densities of denitrifying/nitrifying bacteria were highest-density in surface layer of sediment at both upper and down sites.

It was suggested that the surface layer of sediment was the most important role in nitrogen cycle of Lake Sanaru.

Population Dynamics of *nosZ* gene

Seasonal variation

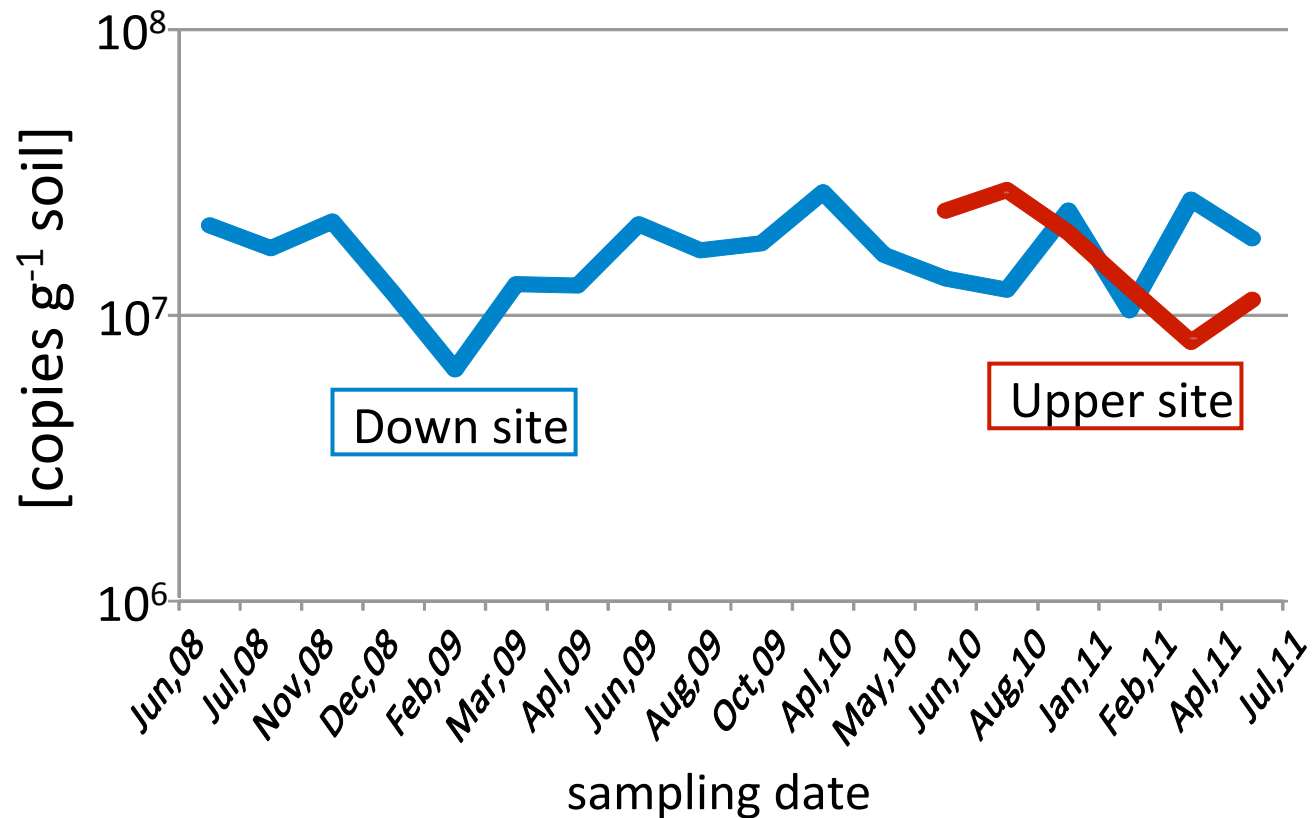

The copy numbers were almost stable at approximately 10^7 copies g^{-1} soil with the upper and down sites.

This result suggest that the potential for nitrous oxide reduction is maintained through the all time.

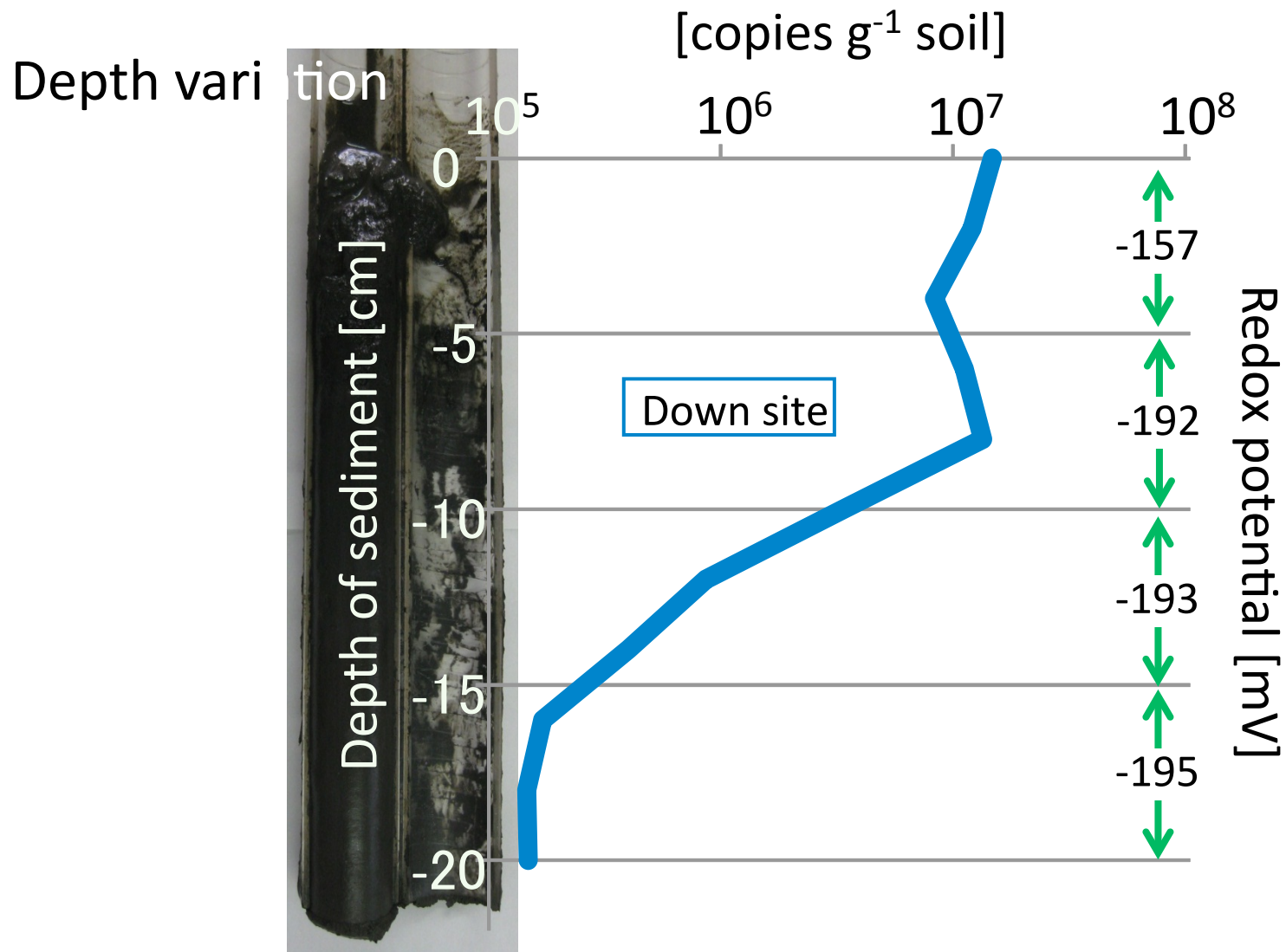

The copy numbers were decreased greatly after around -8cm in depth of the vertical direction.

This result shown that the surface layer of sediment was important environment for expression of *nosZ* gene (complete denitrification).

Functional Analysis of *nosZ* gene

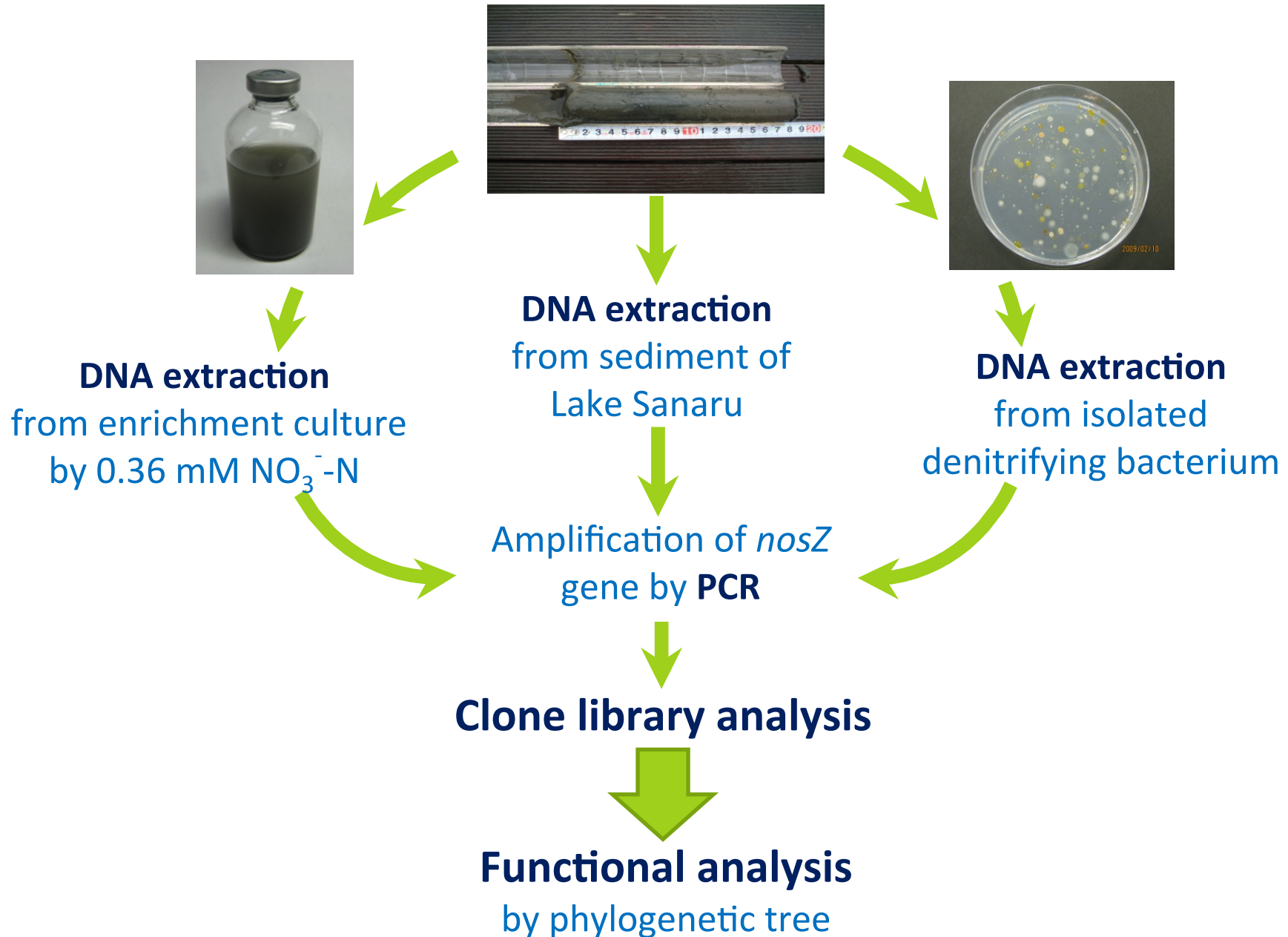

NosZ

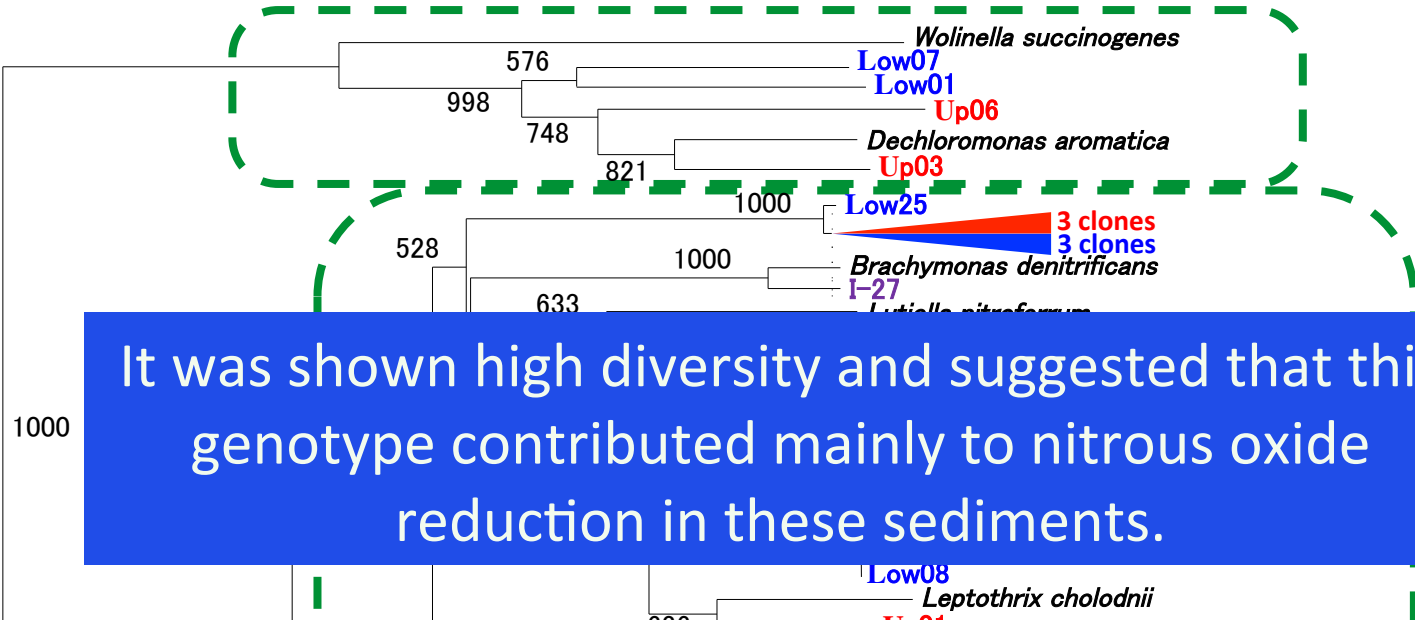

It was shown high diversity and suggested that this genotype contributed mainly to nitrous oxide reduction in these sediments.

We succeeded to make an enrichment culture of the practical denitrifying bacteria in Lake Sanaru.

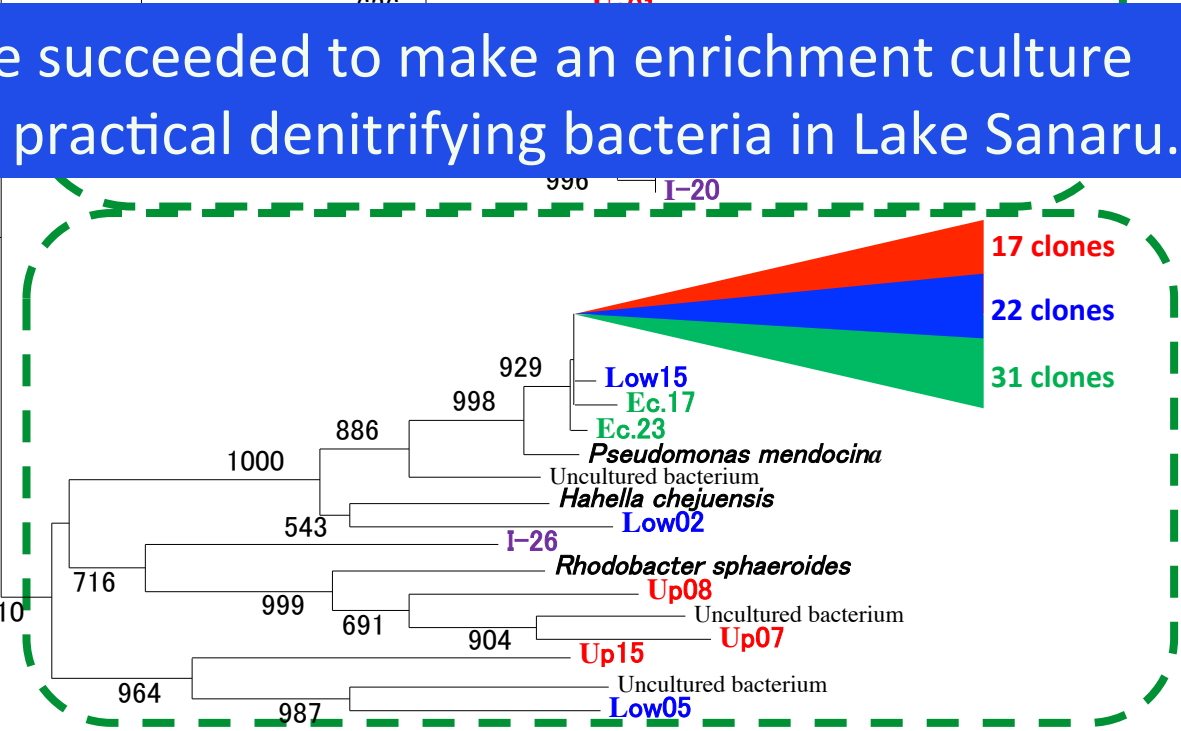

Up : environmental sample of upper site origin clone
 Low : environmental sample of down site origin clone
 Ec. : enrichment culture sample origin clone
 I : isolated strain DNA

Conclusion & Future Plan

- ✿ It was suggested that the potential for reduction of nitrous oxide is maintained through the all time, and that the nitrous oxide reduction exhibits in the surface layer of sediment.
- ✿ A genotype of *nosZ* had a main role although the gene showed high diversity, suggesting that the sediment environment enable to exhibit denitrifying activities corresponding to N-concentration.
- ➔ I'm going to isolate the dominant denitrifying bacteria and analyze it genetically and physiologically .

Characterization of nitrifying bacterial community in lake Sanaru

○YUTO KUDO

MASANORI KURAHASHI HIROYUKI FUTAMATA

Lake Sanaru is a brackish lake and also a representative eutrophied lake in Japan.

Shin River

Upper site

Danzu River

Nitrate (NO_3^-), nitrite (NO_2^-) and ammonium (NH_4^+) cause eutrophic environments.



Shin River

Down site

Kyu-Shin River

We have been studying about nitrogen cycle of microorganisms for clean up the water environment.

Nitrogen cycle

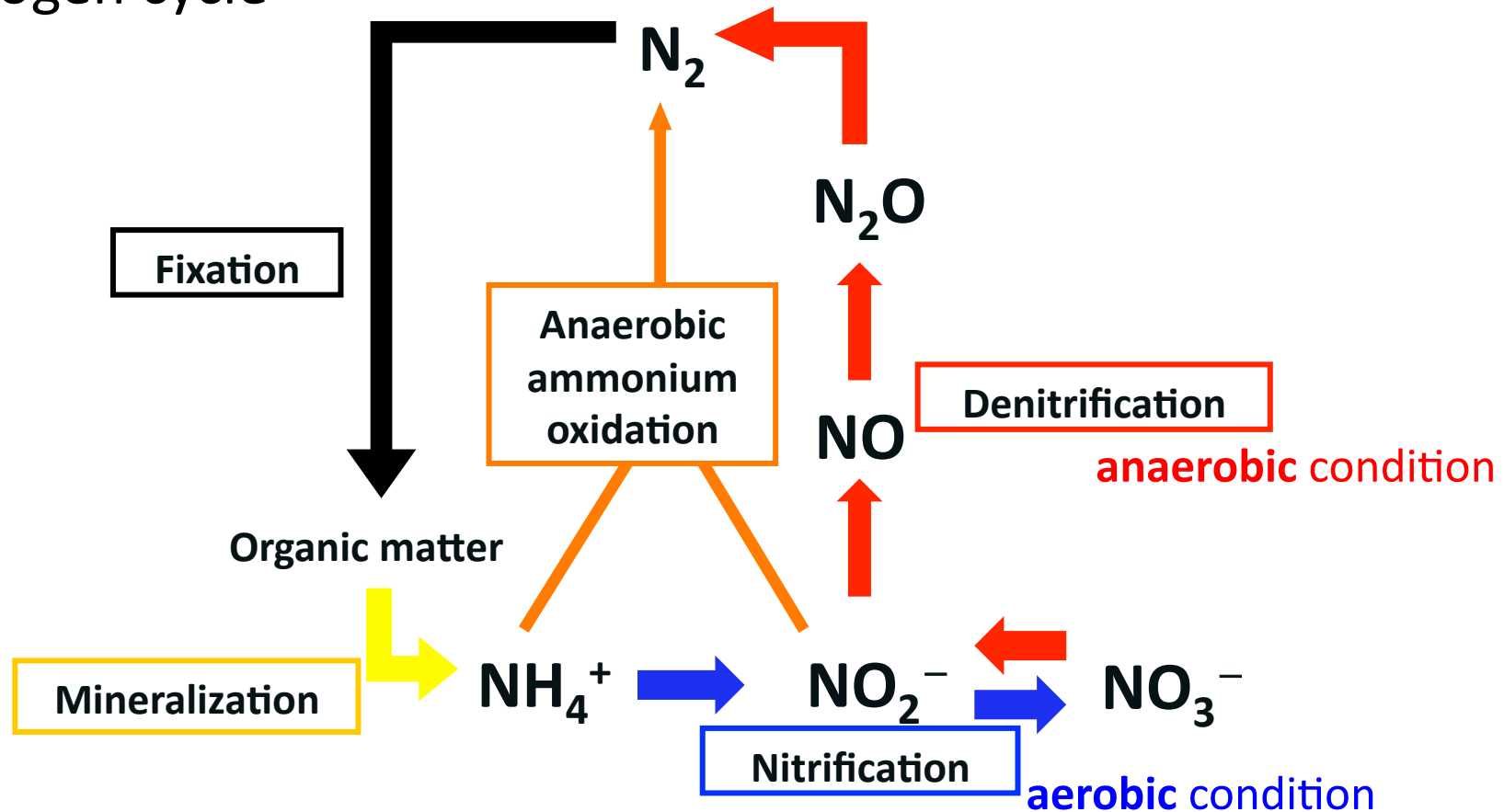

The nitrogen cycle is the process by which nitrogen is converted to its various chemical forms.

Nitrification and denitrification are important processes in the nitrogen cycle.

These processes are carried out by microbes.

Nutritional type of autotrophic bacteria

Nitrifying bacteria are one of the autotrophic bacteria and nitrification has 2 step reactions $\text{NH}_4^+ \rightarrow \text{NO}_2^-$ and $\text{NO}_2^- \rightarrow \text{NO}_3^-$.

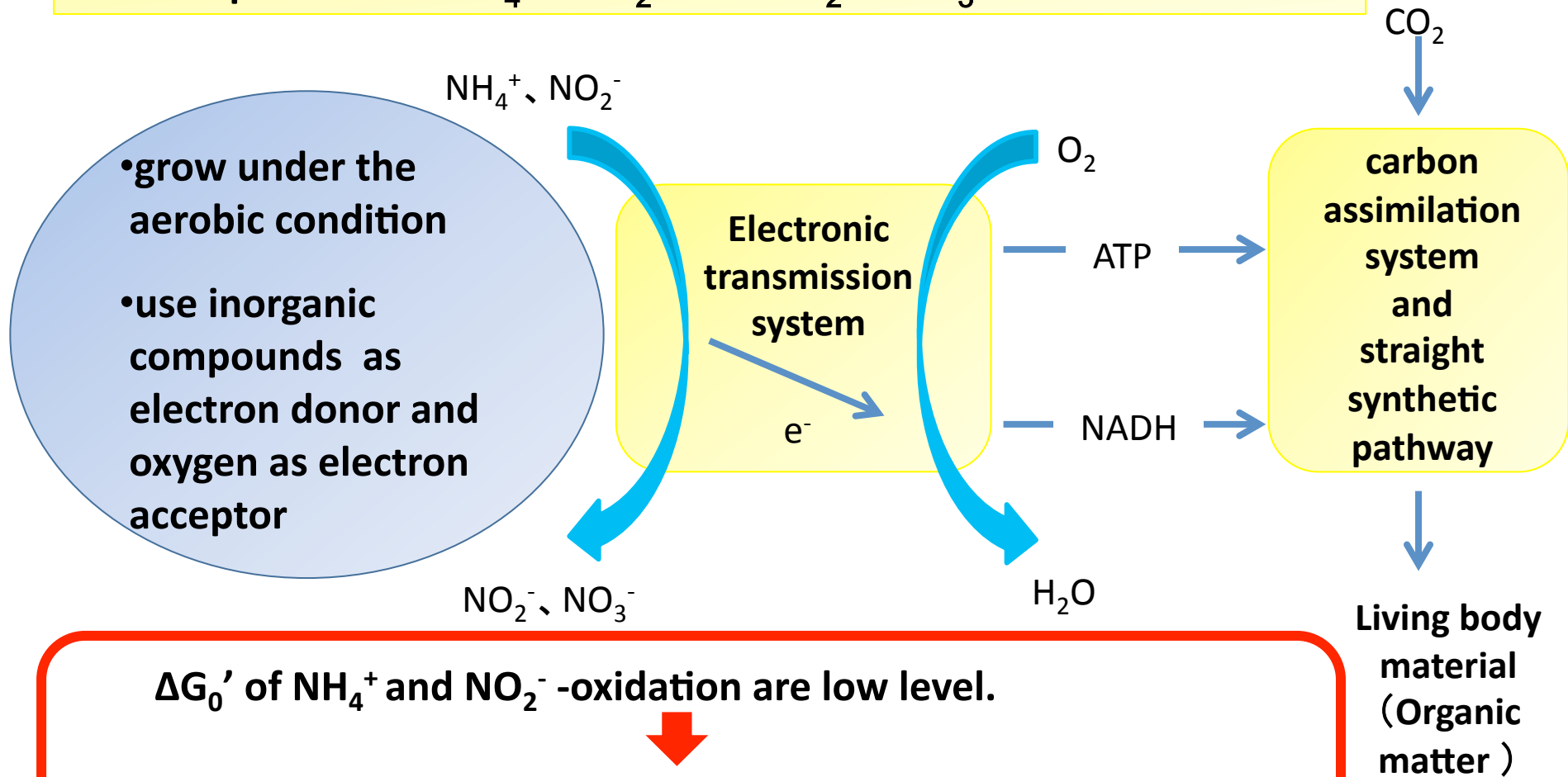

$\Delta G_0'$ of NH_4^+ and NO_2^- -oxidation are low level.

Since the obtained energy is very low, the yield of bacteria is very low.

Kinetic analysis for nitrification

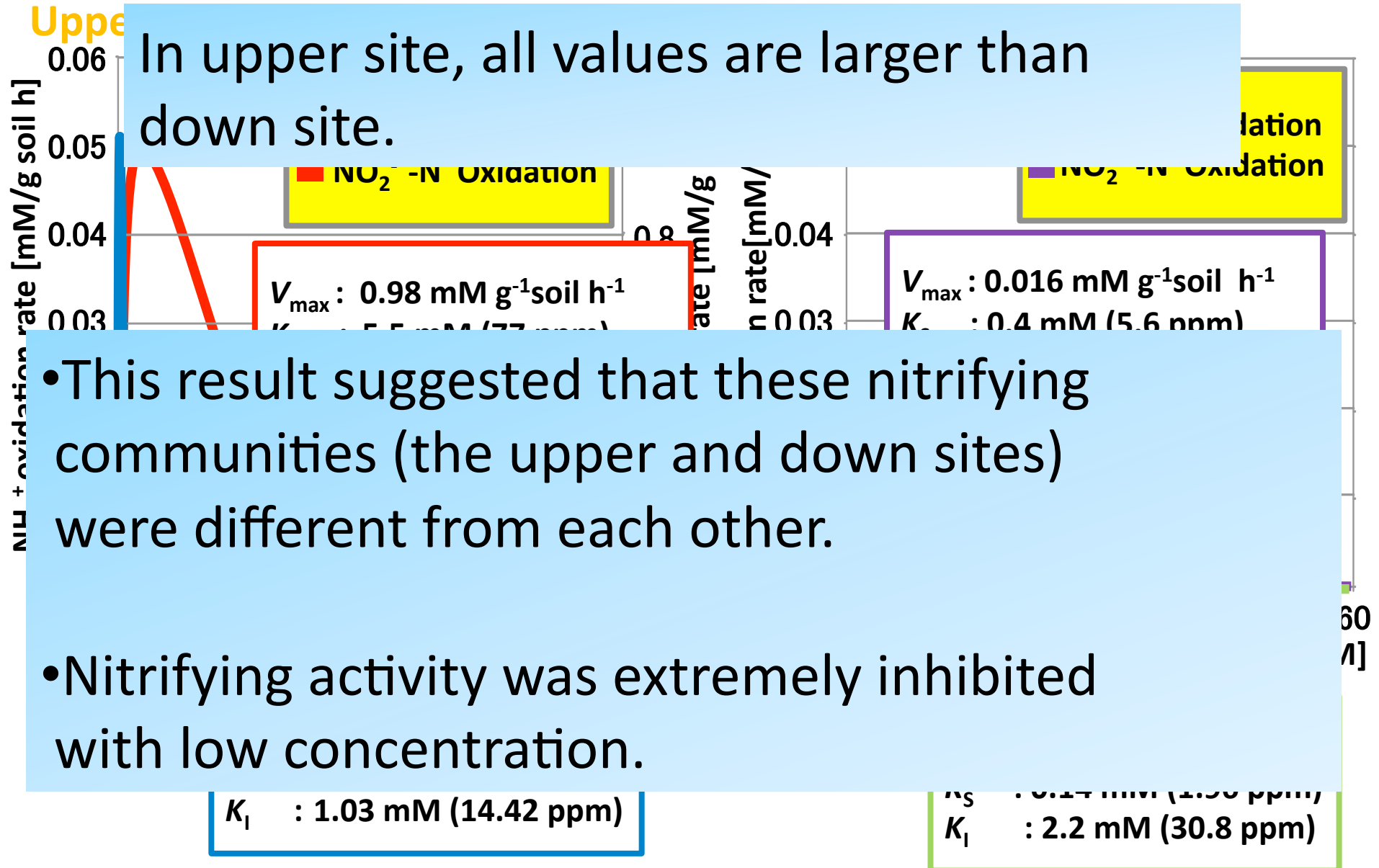

Chemostat culture of the nitrifying bacteria using the Lake Sanaru sediment

Methods of measurement

● NH_4^+-N

indophenol blue method



● NO_2^--N 、 NO_3^--N HPLC

HEPES medium (pH 7.5)
(NH_4^+-N : 720 mM)

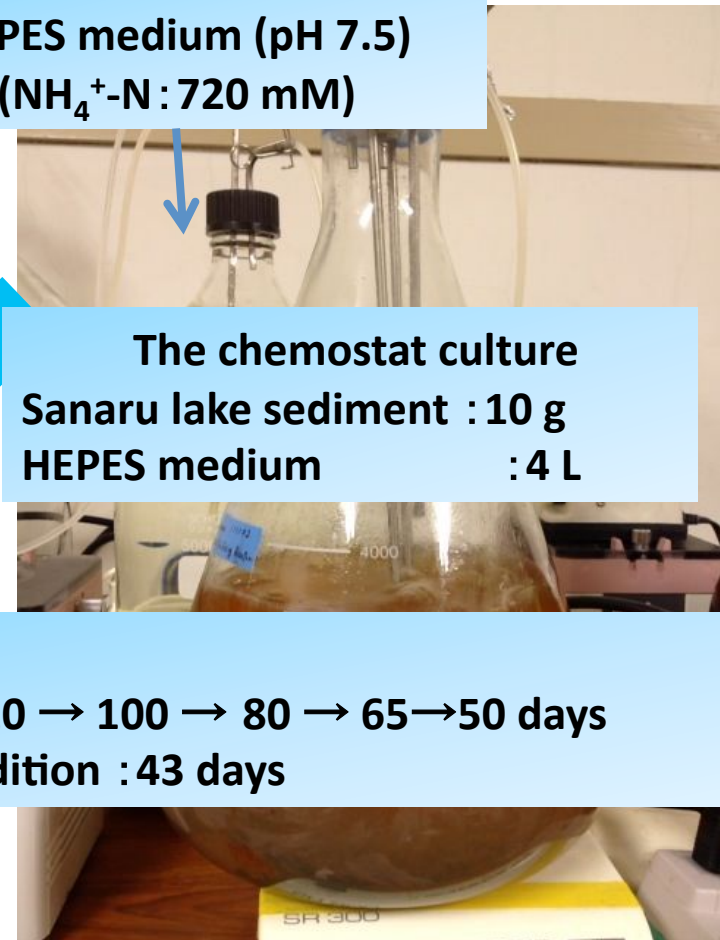

Monitoring of nitrogen concentrations in the chemostat culture

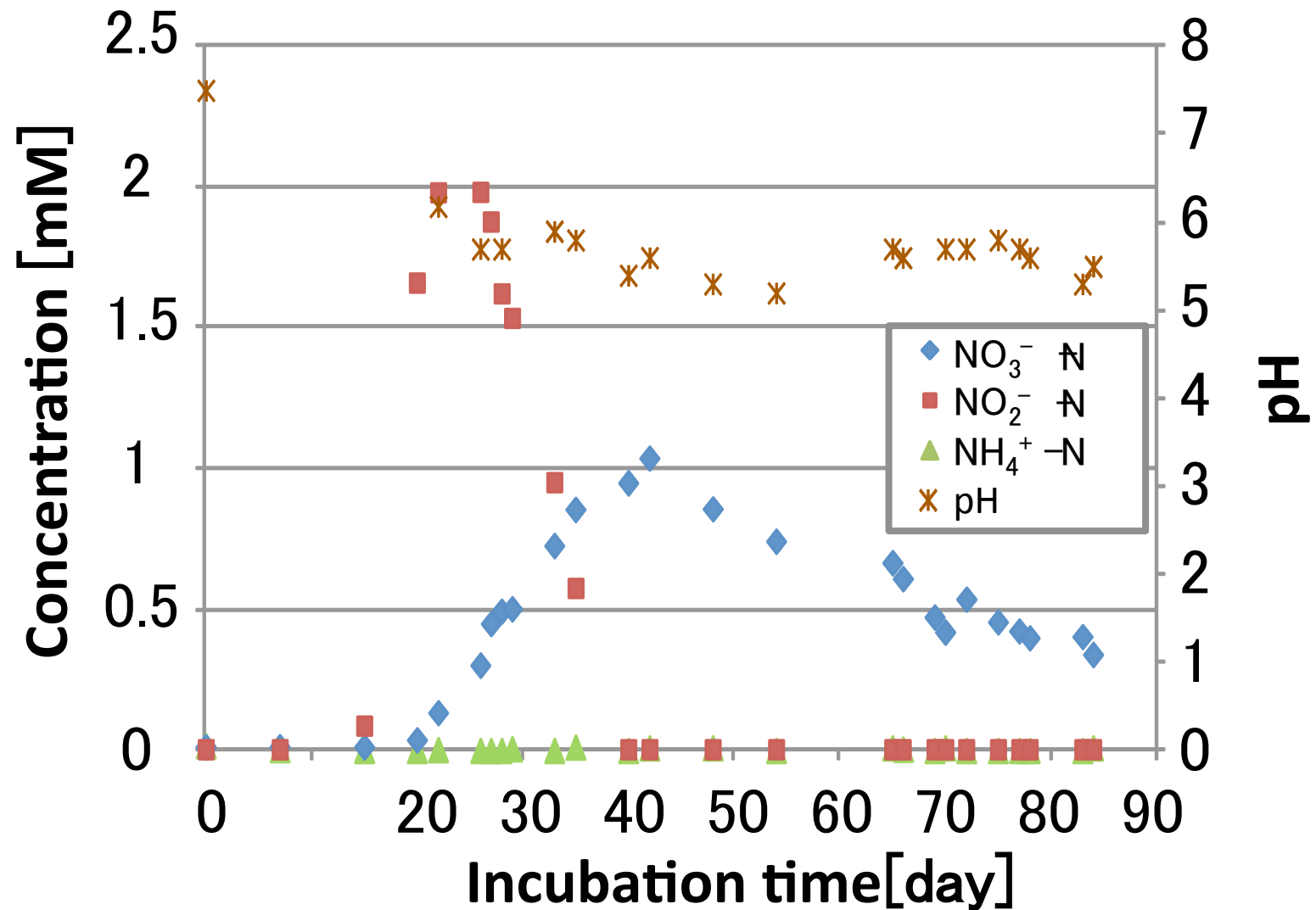

Change of the nitrogen state density in consecutive accumulation culture

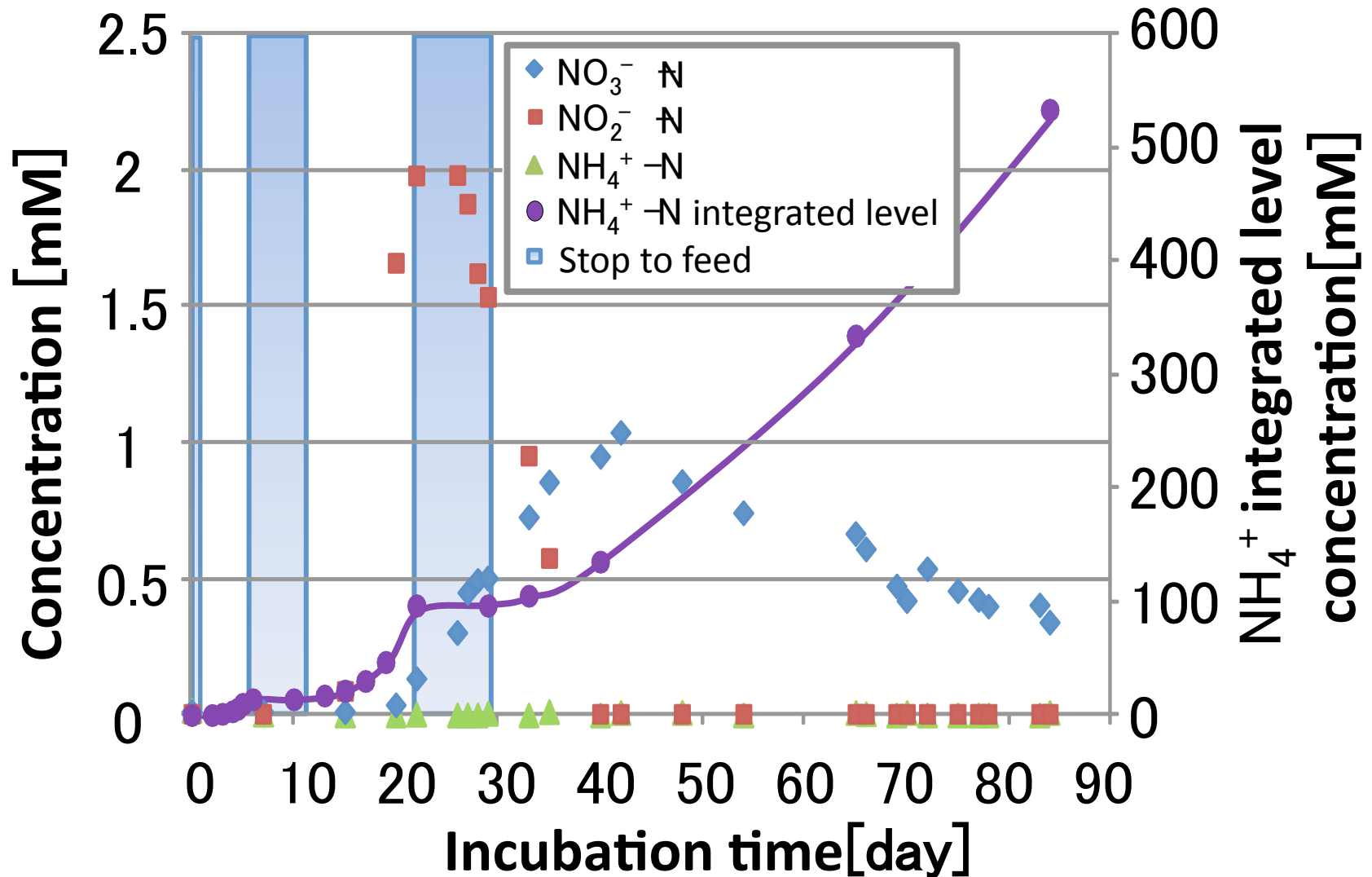

Conclusion

- Kinetic analyses showed that the upper site adapts highly-concentrated level, while the down site adapts low level.

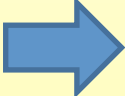
 This result suggested that spatial function was different in lake sanaru.

- Interestingly, the chemostat culture exhibits both nitrifying and denitrifying activities (anammox ?).

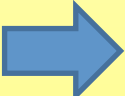
 We try to isolate these bacteria and analyze genetically and physiologically in future.

**THANK YOU FOR YOUR
ATTENTION**

Mechanism of efficient reductive dechlorination for chlorinated ethenes

Shizuoka University
Hiroyuki Morioka



Soil and groundwater pollution in Japan

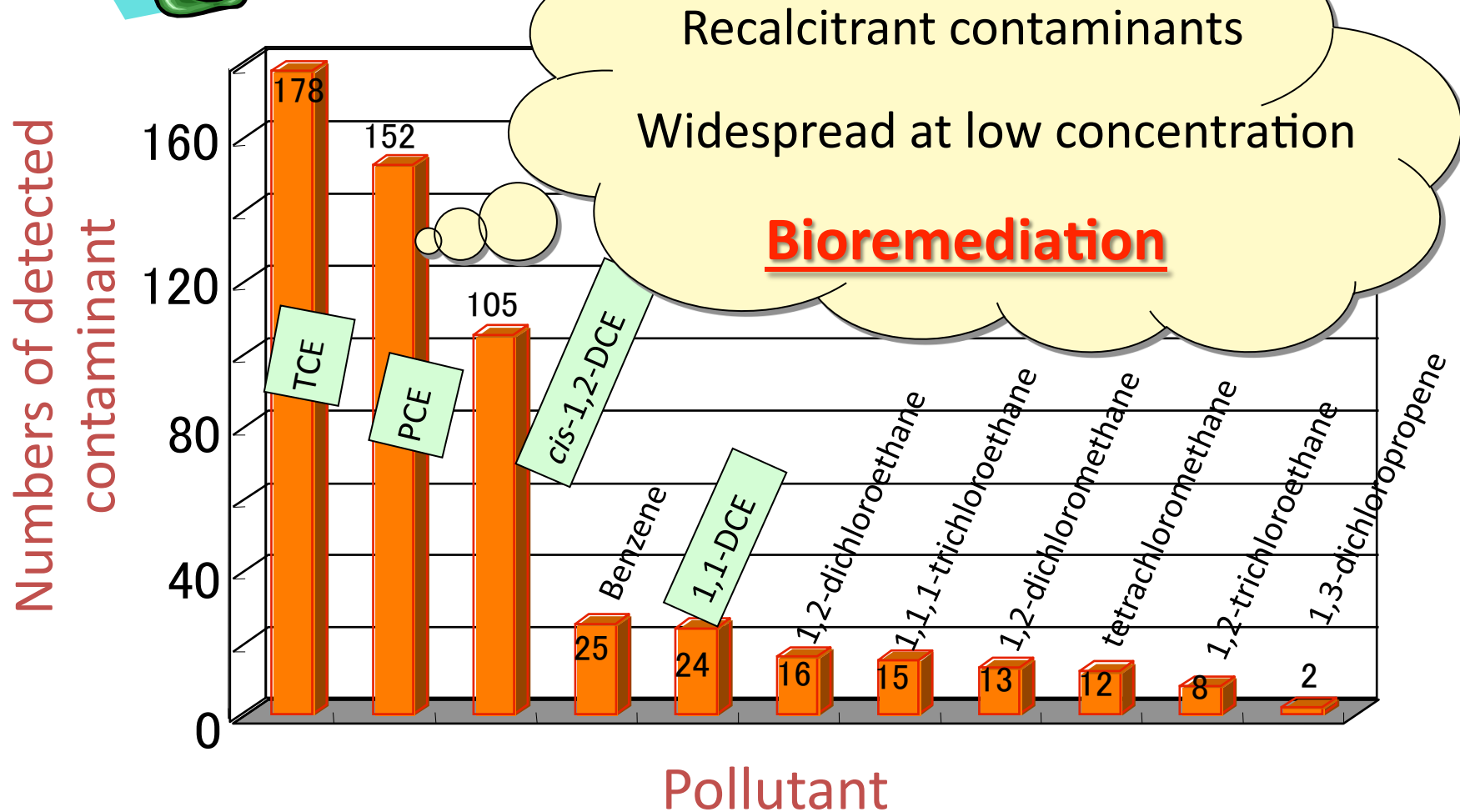

Dechlorination of chlorinated ethenes

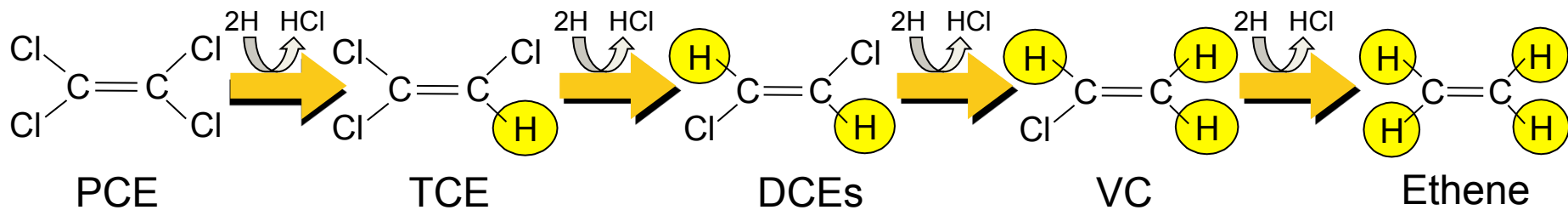
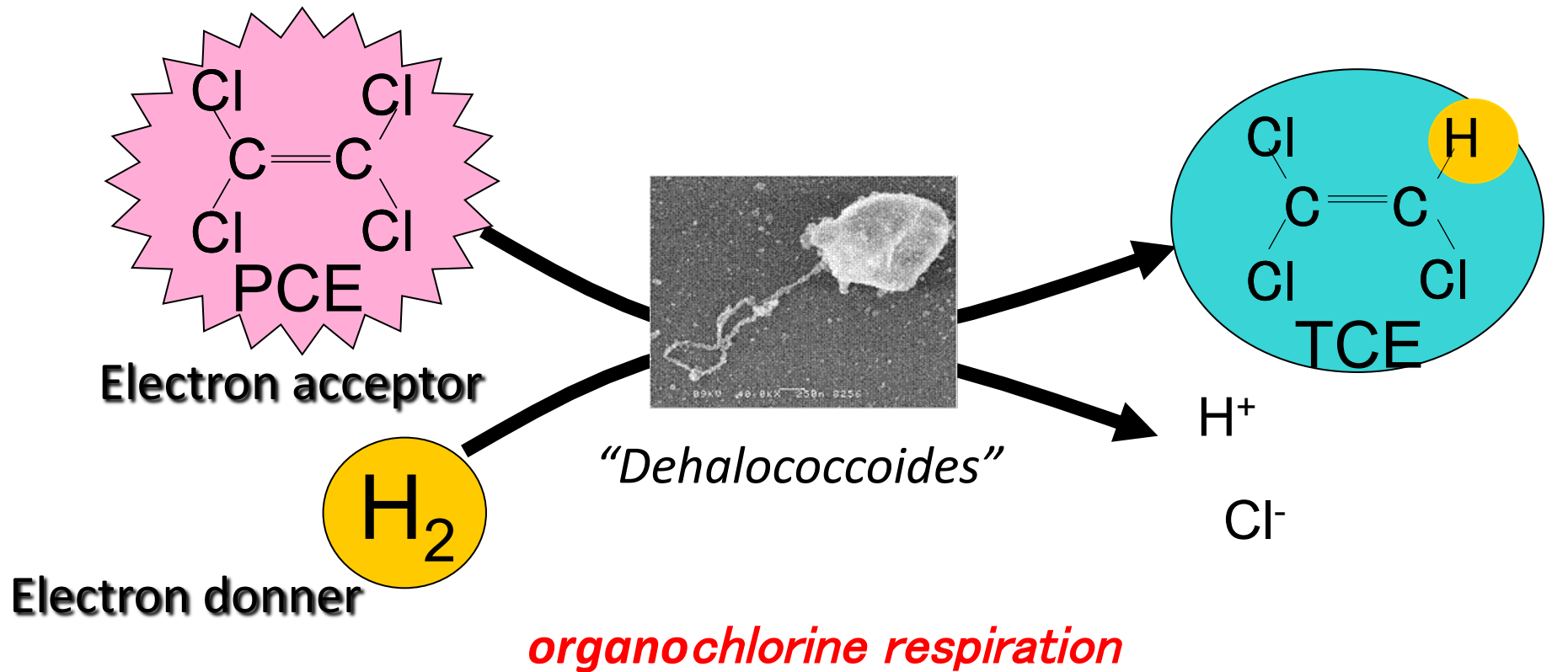

Construction of dechlorinating enrichment cultures

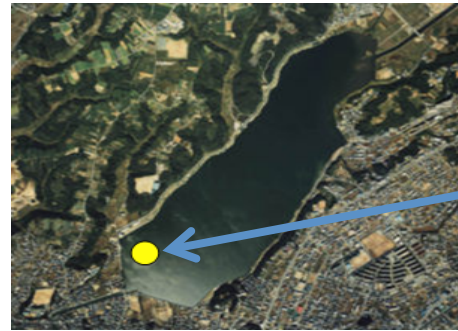
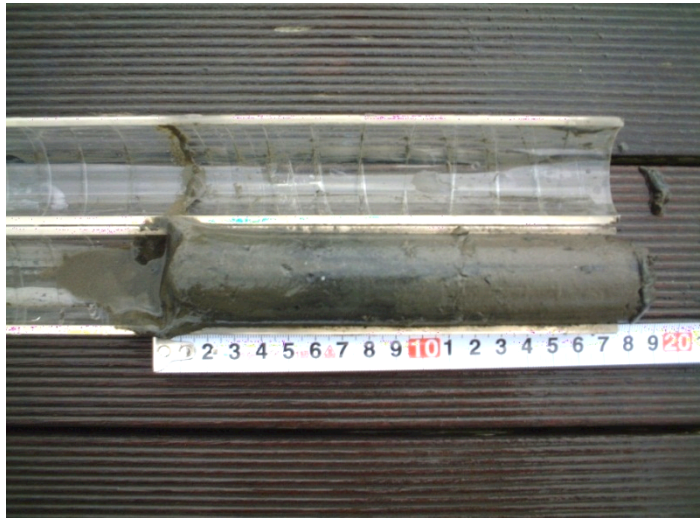

Lake Sanaru

Lake Sanaru the sediment as inoculum, the cultures were constructed.

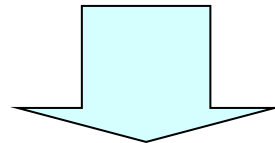

1st LS culture

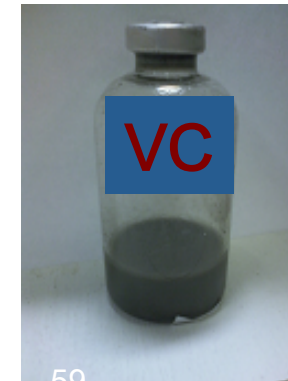
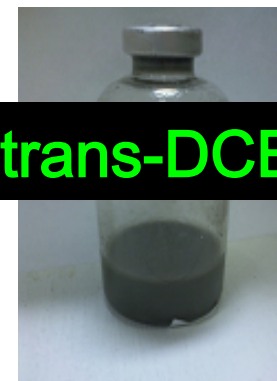

Result

Dechlorination properties of the LS culture

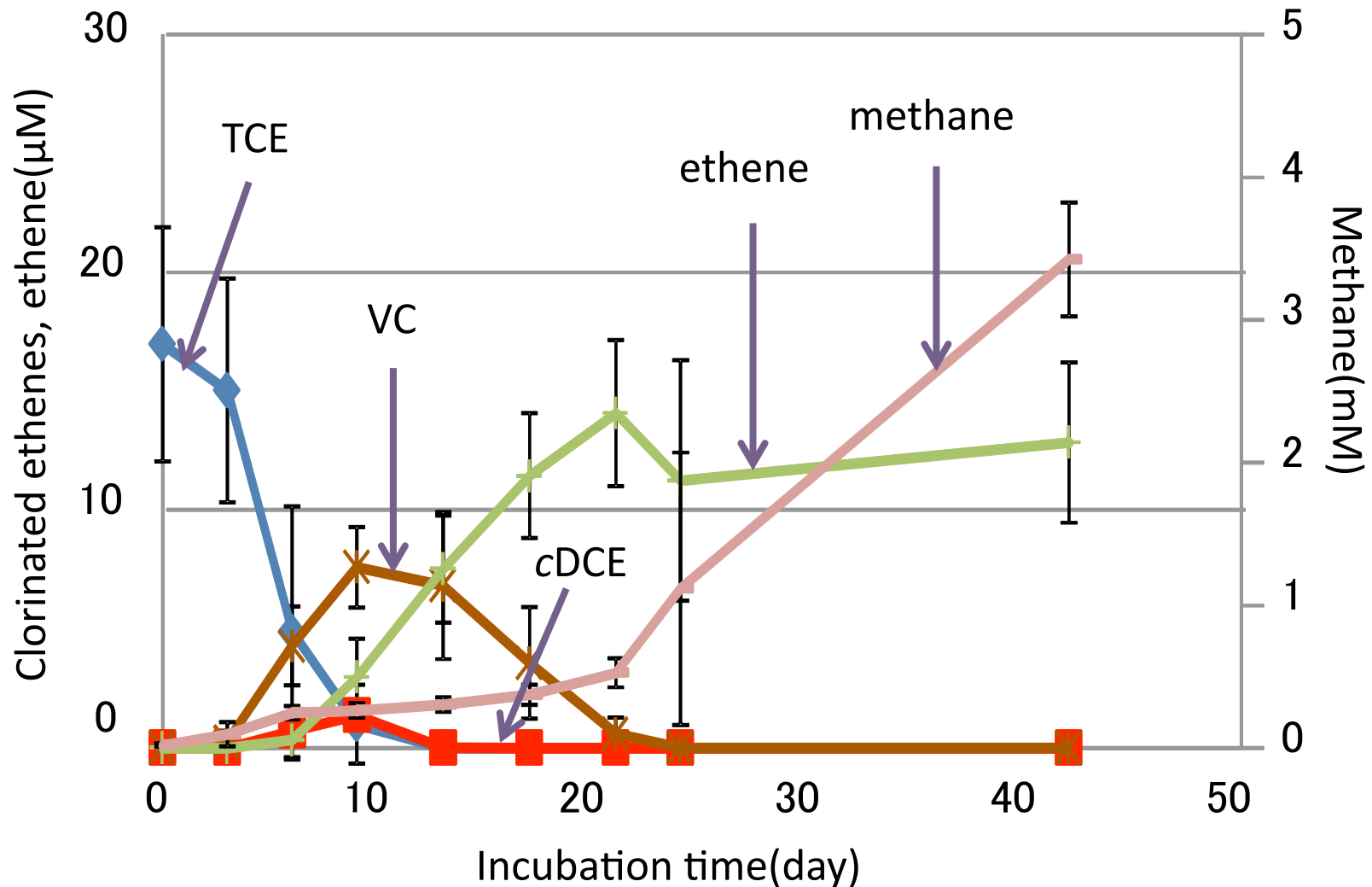

TCE was quickly dechlorinated to ethene which was an end-product in approximately 25 days.

2. Analysis of *Dehalococcoides* sp. in LS culture

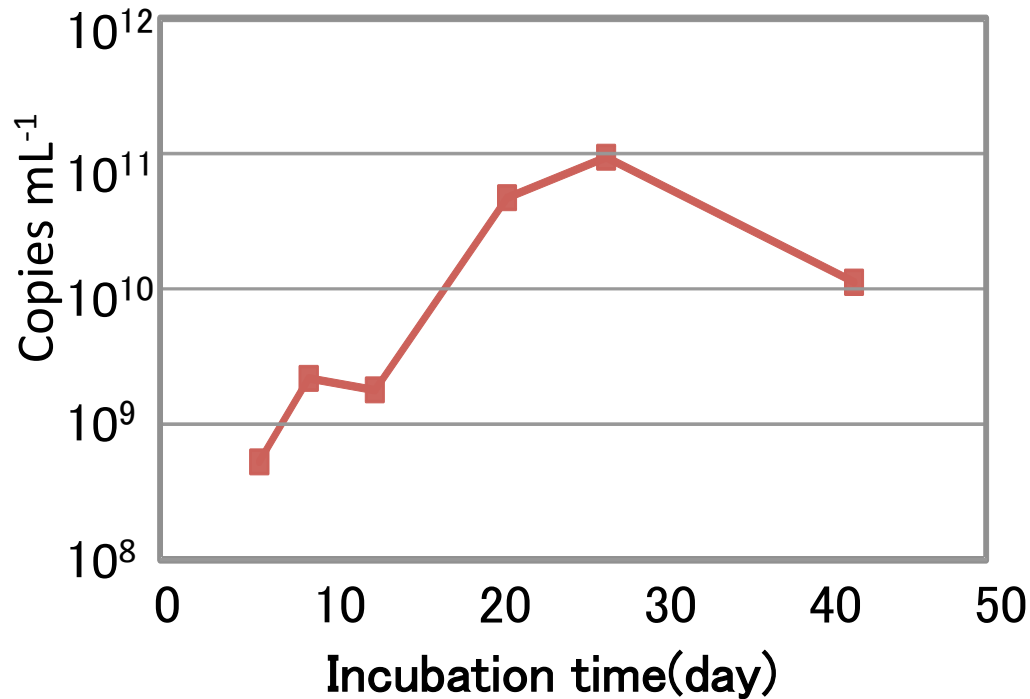

***Dehalococcoides* sp. copies number**

Dehalogenimonas lykanthroporepellens BL-DC-9

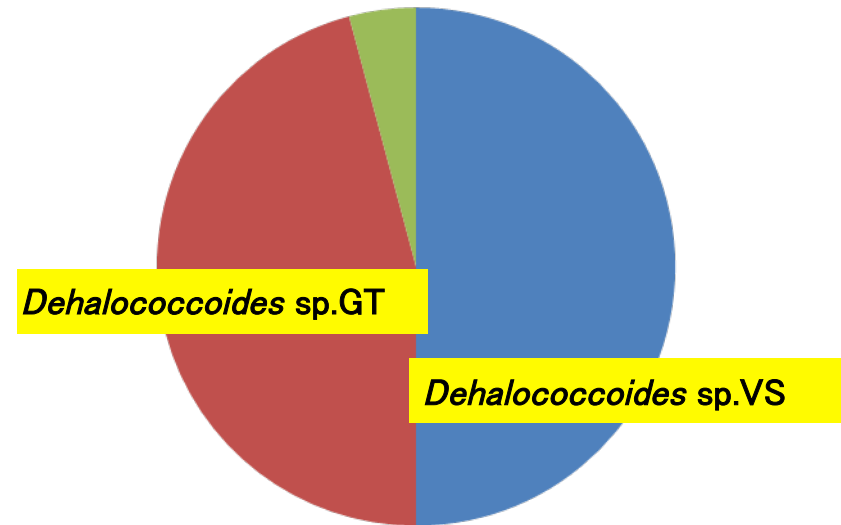

***Dehalococcoides* sp. 16S rRNA clone analysis**

- *Dehalococcoides* sp. copies number increased with dechlorination.
→ It is assumed that dechlorination in the LS culture depends on *Dehalococcoides* sp.
- There were *Dehalococcoides* sp. GT and *Dehalococcoides* sp. VS that can dechlorinate TCE, cDCE, tDCE and VC in the LS culture.

Conclusion

- Constructed to the enrichment cultures which can completely dechlorinate from TCE (trichloroethene) to ethene.
- The dechlorination in the LS culture depend on *Dehalococcoides* sp. VS and *Dehalococcoides* sp. GT.

Future

- Attempt to isolate microbes which related to dechlorination in the enrichment culture.
- Analyze of microbial community structure in the LS.

🍷 Thank you for listening 🍷